

FASTENER IDENTIFICATION GUIDE

October 3, 2008



Illinois Department of Transportation

Revision Information Log
Guide for Approved Fasteners
October 3, 2008

Effective Date	Description of Change	Authorized By
03/21/08	Date added to guide cover	Ray Rowden
03/21/08	Revision Information Log added	Ray Rowden
05/15/08	Dyson Corporation – New Nut Drawings	Ray Rowden
05/16/08	Andre' Corporation – New Washer Drawings	Ray Rowden
05/16/08	Nucor Fasteners – New Bolt Drawings	Ray Rowden
05/23/08	Technical Stamping Incorporated – New Washer (Ty-3)	Ray Rowden
10/03/2008	St. Louis Screw & Bolt – New Bolt Drawings	Ray Rowden
10/03/2008	Decker Manufacturing Corp. – New Nut Drawings	Ray Rowden
10/03/2008	Vegas Fastener Manufacturing – New Bolt Drawings	Ray Rowden
10/03/2008	Prestige Stamping – New Washer Drawings	Ray Rowden
10/03/2008	Mid-West Fabricating – New Bolt Drawings	Ray Rowden

INSTRUCTIONS FOR IDENTIFICATION FOR BOLTS AND STUDS

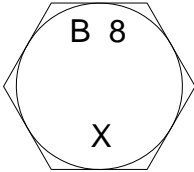
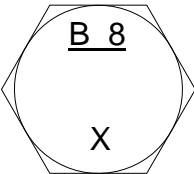
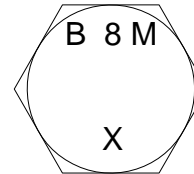
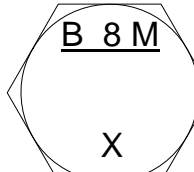
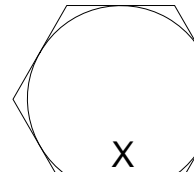
SPECIFICATION AND MATERIAL CODES	GRADE MARKING	REQUIRED MARKINGS
<p>ASTM A 193 Grade B8 Class 1 Regular Series and Heavy Series.</p> <p>67608 Stud, Stain.Steel 67623</p>		<p>Symbol for identification of grade, i.e., "B8", applied to head.</p> <p>Manufacturer's identification mark, e.g., "X" (on head of bolts and screws and on one end of studs and studs-bolts).</p>
<p>ASTM A 193 Grade B8 Class 2 (Strain Hardened Material) Regular Series and Heavy Series</p> <p>67609 Stud, Stain. Steel 67624</p>		<p>Symbol for identification of grade, i.e., "B8", applied to head.</p> <p>Line stamped under "B8".</p> <p>Manufacturer's identification mark, e.g., "X" (on head of bolts and screws and on one end of studs and stud bolts).</p>
<p>ASTM A 193 Grade B8M Class 1 Regular Series and Heavy Series</p> <p>67610</p>		<p>Symbol for identification of grade, i.e., "B8M", applied to head.</p> <p>Manufacturer's identification mark, e.g., "X" (on head of bolts and screws and on one end of studs and stud bolts).</p>
<p>ASTM A 193 Grade B8M Class 2 (Strain Hardened Material) Regular Series and Heavy Series</p> <p>67611</p>		<p>Symbol for identification of grade, i.e., "B8M", applied to head.</p> <p>Line stamped under "B8M".</p> <p>Manufacturer's identification mark, e.g., "X" (on head of bolts and screws and on one end of studs and stud bolts).</p>
<p>ASTM A 307* Grade A Grade B Regular 'series and Heavy Series</p> <p>A or B 67614 B only 67613 Galv. A or B 67614 Galv. B only 67615 Cad. Plated A only 67634 Cad. plated B only 67635</p> <p>Square head: (same as above) Round Slotted: 67625 Glav. 67627 Round Slotted Countersunk: (same as round slotted)</p>		<p>Manufacturer's identification mark, e.g., "X", applied to head (raised or depressed at option of manufacturer).</p> <p>*When ASTM A 307 bolts are submitted for testing and the grade is not know, it is suggested that the material code for Grade A or B is used.</p>





Typical:

Hex Galv.--67643
Hex Alum.--77601

Round Galv.--67631
Round Alum.--77602

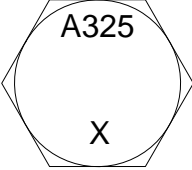
Stainless Steel--67604
Shear Connector Stud--65801

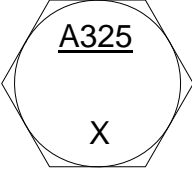
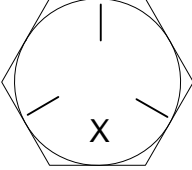
INSTRUCTIONS FOR IDENTIFICATION FOR BOLTS AND STUDS

SPECIFICATION AND MATERIAL CODES	GRADE MARKING	REQUIRED MARKINGS
<p>ASTM A 325 Type 1 Heavy Series . 65501 Galv. 67616</p> <p>Dual Ring: (same as above) Round Countersunk: (same as above) Torque: 65505</p>	 	<p>Symbol for identification of grade, i.e., "A325", applied to head.</p> <p>Manufacturer's identification mark, e.g., "X", applied to head (raised or depressed at option of manufacturer).</p> <p>Three radial lines applied to head 120 degrees apart (at option of the manufacturer).</p>
<p>ASTM A 325 Type 2 Heavy Series</p> <p>65502 Galv. 67616</p>		<p>Symbol for identification of grade, i.e., "325", applied to head.</p> <p>Manufacturer's identification mark, e.g., "X", Applied to head (raised or depressed at option of the manufacturer).</p> <p>Three radial lines applied to head 60 degrees apart.</p>
<p>ASTM A 325 Type 3 Heavy Series</p> <p>65503 Galv. 67650</p> <p>Torque: (same as above) Round Countersunk: (same as above)</p>		<p>Symbol for identification of grade, i.e., "325", applied to head.</p> <p>Line stamped under "A325".</p> <p>Manufacturer's identification mark, e.g., "X", Applied to head (raised or depressed at option of the manufacturer).</p> <p>Other distinguishing marks applied to head indicating bolt is atmospheric corrosion resistant and of a weathering type (at option of manufacturer).</p>
<p>ASTM A 449 Regular Series</p> <p>67617M Galv. 67618M</p>		<p>Manufacturer's identification mark, e.g., "X", Applied to head (raised or depressed at option of the manufacturer).</p> <p>Three radial lines applied to head 120 degrees apart.</p>
<p>ASTM A 490 Type 1 Heavy Series</p> <p>67619 Galv. 67620</p>		<p>Symbol for identification of grade, i.e., "490", applied to head.</p> <p>Manufacturer's identification mark, e.g., "X", applied to head (raised or depressed at option of manufacturer).</p>

Typical:

Hex Galv.--67643
Hex Alum.--77601

Round Galv.--67631
Round Alum.--77602

Stainless Steel--67604
Shear Connector Stud--65801

INSTRUCTIONS FOR IDENTIFICATION FOR BOLTS AND STUDS

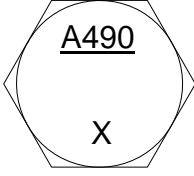
SPECIFICATION AND MATERIAL CODES	GRADE MARKING	REQUIRED MARKINGS
ASTM A 490 Type 2 Heavy Series .		Symbol for identification of grade, i.e., "A490", applied to head. Manufacturer's identification mark, e.g., "X", applied to head (raised or depressed at option of manufacturer). Six radial lines applied to head 30 degrees apart.
ASTM A 490 Type 3 Heavy Series		Symbol for identification of grade, i.e., "490", applied to head. Line Stamped under "A 490". Manufacturer's identification mark, e.g., "X", Applied to head (raised or depressed at option of the manufacturer).

Typical:

Hex Galv.--67643
Hex Alum.--77601

Round Galv.--67631
Round Alum.--77602

Stainless Steel--67604
Shear Connector Stud--65801

Fasteners - Bolts

01-Oct-08

P/S#	P/S Name	City	State	EDate	Status
------	----------	------	-------	-------	--------

4505-01

4505-01	A & G Engineering Co.	Anaheim	CA		
Bolt	A 307 Gr A/B Blk	M/C 67612		12/8/1998	APPR

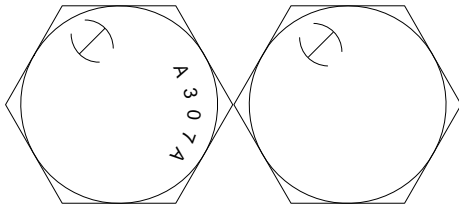

4505-01	A & G Engineering Co.	Anaheim	CA		
Bolt	A 307 Gr A/B Gv	M/C 67614		12/8/1998	APPR

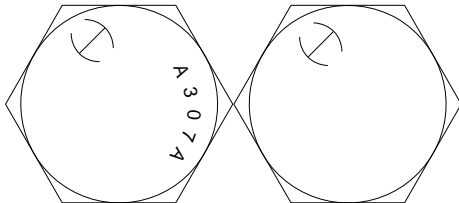

4505-01	A & G Engineering Co.	Anaheim	CA		
Bolt	A 325 Ty 1 Blk	M/C 65501		12/8/1998	APPR

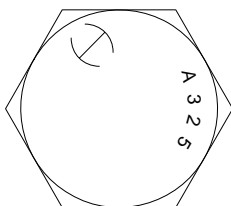

P/S#	P/S Name	City	State	EDate	Status
------	----------	------	-------	-------	--------

4505-01	A & G Engineering Co.	Anaheim	CA		
Bolt	A 325 Ty 1 Gv	M/C 67616		12/8/1998	APPR

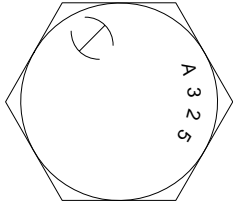

4505-01	A & G Engineering Co.	Anaheim	CA		
Bolt	A 490 Ty 1 Blk	M/C 67619		12/8/1998	APPR

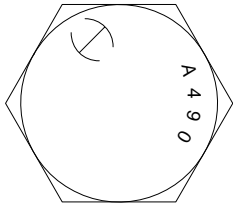

P/S#	P/S Name	City	State	EDate	Status
------	----------	------	-------	-------	--------

5760-01

5760-01	All Pro Fastener, Inc.	Arlington	TX		
Bolt	A 394 Ty-O Galv	M/C 67671		10/18/2001	APPR

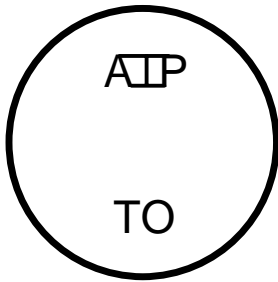

P/S#	P/S Name	City	State	EDate	Status
------	----------	------	-------	-------	--------

4399-01

4399-01 Alpine Bolt & Forming Marengo IL
 Bolt A 307 Gr A/B Blk M/C 67612 12/8/1998 APPR

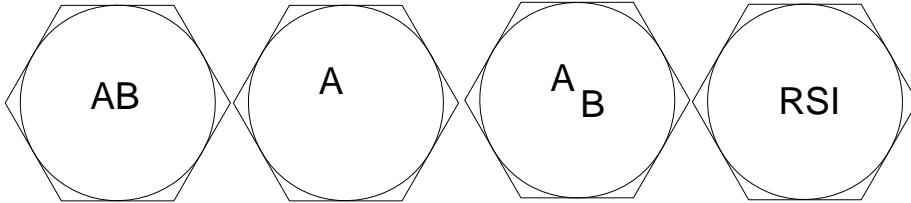

4399-01 Alpine Bolt & Forming Marengo IL
 Bolt A 307 Gr A/B Gv M/C 67614 12/8/1998 APPR

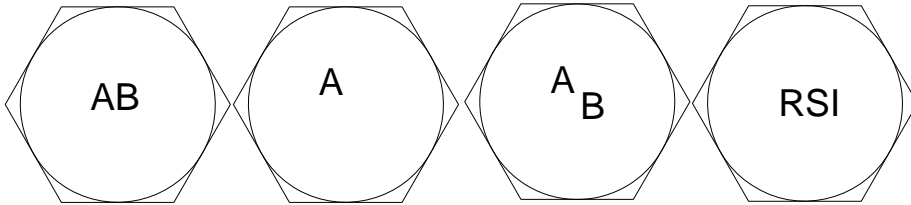

4399-01 Alpine Bolt & Forming Marengo IL
 Bolt A 307 Rnd Head Gv M/C 67631 12/8/1998 APPR

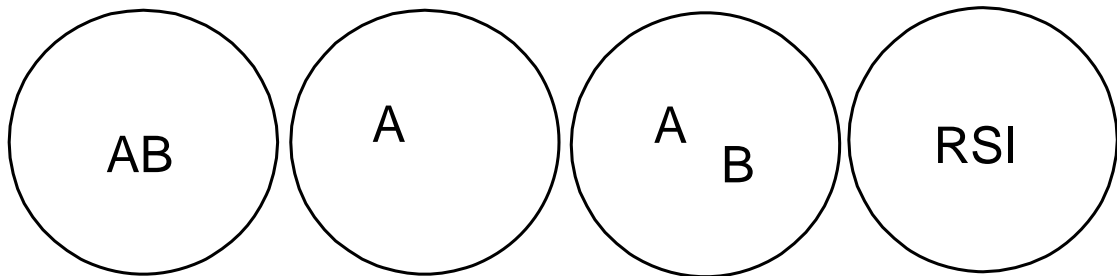

P/S#	P/S Name	City	State	EDate	Status
------	----------	------	-------	-------	--------

4756-01

4756-01	Auto Bolt & Nut	Cleveland	OH		
Bolt	A 307 Gr A/B Blk	M/C 67612		12/8/1998	APPR

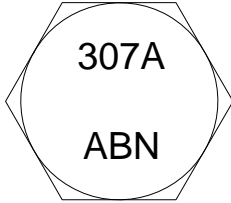

4756-01	Auto Bolt & Nut	Cleveland	OH		
Bolt	A 307 Gr A/B Gv	M/C 67614		12/8/1998	APPR

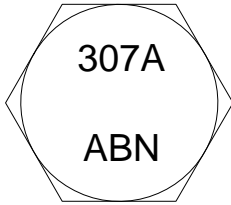

4756-01	Auto Bolt & Nut	Cleveland	OH		
Bolt	A 307 Gr B Blk	M/C 67613		12/8/1998	APPR

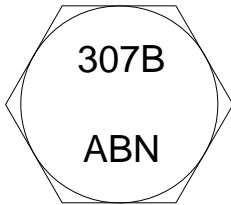

P/S#	P/S Name	City	State	EDate	Status
------	----------	------	-------	-------	--------

4756-01	Auto Bolt & Nut	Cleveland	OH		
Bolt	A 307 Gr B Gv	M/C 67615		12/8/1998	APPR

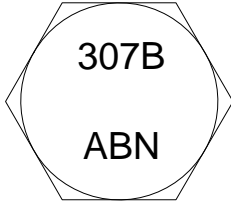

4756-01	Auto Bolt & Nut	Cleveland	OH		
Bolt	A 325 Ty 1 Blk	M/C 65501		12/8/1998	APPR

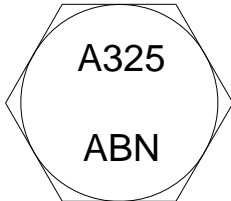

4756-01	Auto Bolt & Nut	Cleveland	OH		
Bolt	A 325 Ty 1 Gv	M/C 67616		12/8/1998	APPR

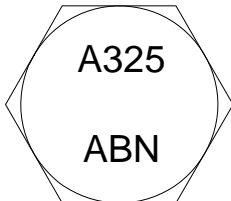

P/S#	P/S Name	City	State	EDate	Status
------	----------	------	-------	-------	--------

4756-01	Auto Bolt & Nut	Cleveland	OH		
Bolt	A 449 Blk	M/C 67617		12/8/1998	APPR

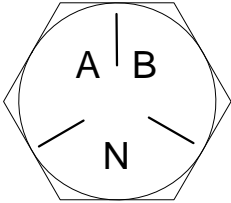

4756-01	Auto Bolt & Nut	Cleveland	OH		
Bolt	A 449 Gv	M/C 67618		12/8/1998	APPR

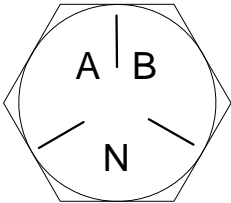

4756-01	Auto Bolt & Nut	Cleveland	OH		
Bolt	A 490 Ty 1 Blk	M/C 67619		12/8/1998	APPR

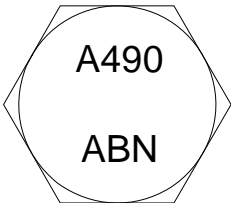

P/S#	P/S Name	City	State	EDate	Status
------	----------	------	-------	-------	--------

224-02

224-02 BBC Fasteners Alsip IL
 Bolt A 307 Rnd Slot Blk M/C 67625 12/8/1998 APPR

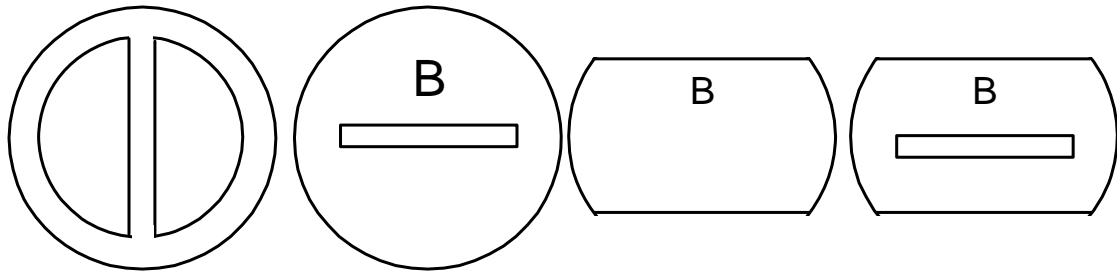

224-02 BBC Fasteners Alsip IL
 Bolt A 307 Rnd Slot Cnt Gv M/C 67627 12/8/1998 APPR

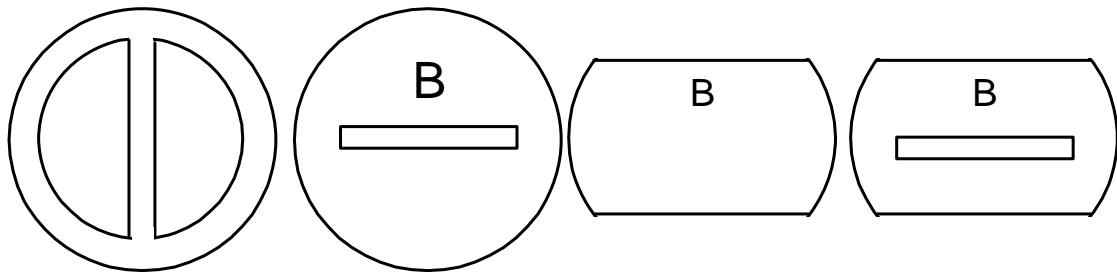

224-02 BBC Fasteners Alsip IL
 Bolt A 307 Sqr Head Blk M/C 67614 12/8/1998 APPR

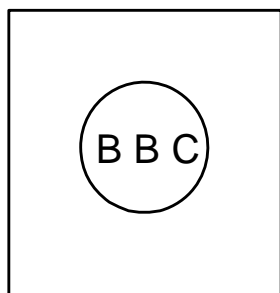

P/S#	P/S Name	City	State	EDate	Status
------	----------	------	-------	-------	--------

224-02	BBC Fasteners	Alsip	IL		
Bolt	A 307 Sqr Head Gv	M/C 67614		12/8/1998	APPR

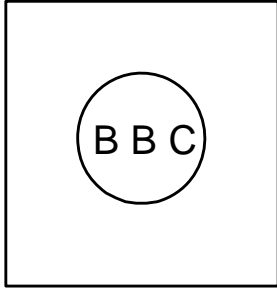

224-02	BBC Fasteners	Alsip	IL		
Bolt	A 325 Ty 1 Blk	M/C 65501		12/8/1998	APPR

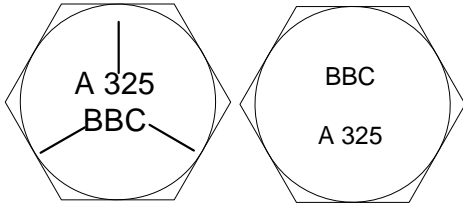

224-02	BBC Fasteners	Alsip	IL		
Bolt	A 325 Ty 1 Gv	M/C 67616		12/8/1998	APPR

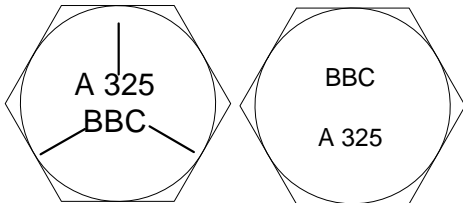

P/S#	P/S Name	City	State	EDate	Status
------	----------	------	-------	-------	--------

224-02	BBC Fasteners	Alsip	IL		
Bolt	A 325 Ty 3 Blk	M/C 65503		12/8/1998	APPR

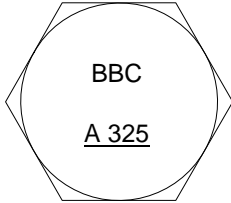

224-02	BBC Fasteners	Alsip	IL		
Bolt	A 490 Ty 1 Blk	M/C 67619		12/8/1998	APPR

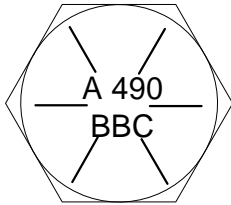

224-02	BBC Fasteners	Alsip	IL		
Bolt	A 490 Ty 3 Blk	M/C 67673		12/8/1998	APPR

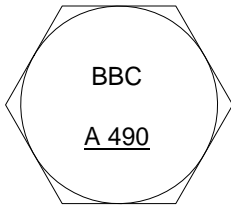

P/S#	P/S Name	City	State	EDate	Status
------	----------	------	-------	-------	--------

4721-01

4721-01 Birmingham Fastener Supply Birmingham AL
 Bolt A 307 Gr A/B Blk M/C 67612 12/8/1998 APPR

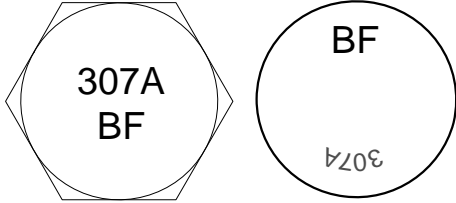

4721-01 Birmingham Fastener Supply Birmingham AL
 Bolt A 307 Gr A/B Gv M/C 67614 12/8/1998 APPR

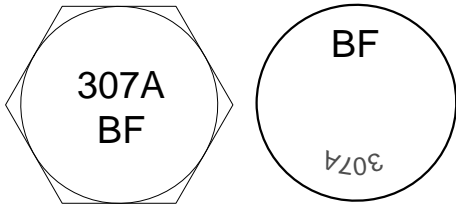

4721-01 Birmingham Fastener Supply Birmingham AL
 Bolt A 307 Gr B Blk M/C 67613 12/8/1998 APPR

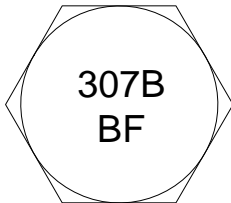

P/S#	P/S Name	City	State	EDate	Status
4721-01	Birmingham Fastener Supply	Birmingham	AL		
Bolt	A 307 Gr B Gv	M/C 67615		12/8/1998	APPR

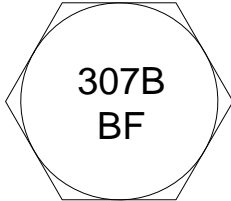

P/S#	P/S Name	City	State	EDate	Status
------	----------	------	-------	-------	--------

309-01

309-01 Cardinal Fastener & Specialty Bedford Heights OH
 Bolt A 325 Ty 1 Blk M/C 65501 6/13/2000 APPR

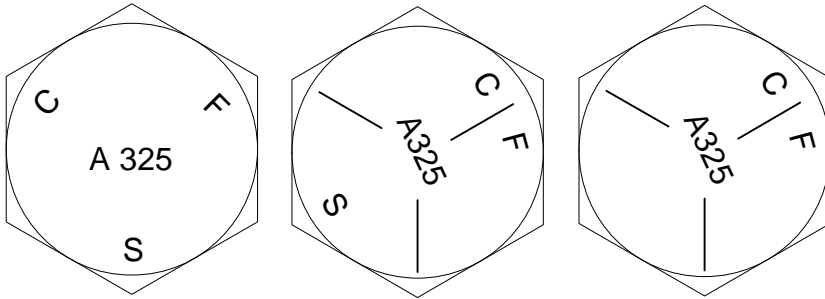

309-01 Cardinal Fastener & Specialty Bedford Heights OH
 Bolt A 325 Ty 1 Gv M/C 67616 6/13/2000 APPR

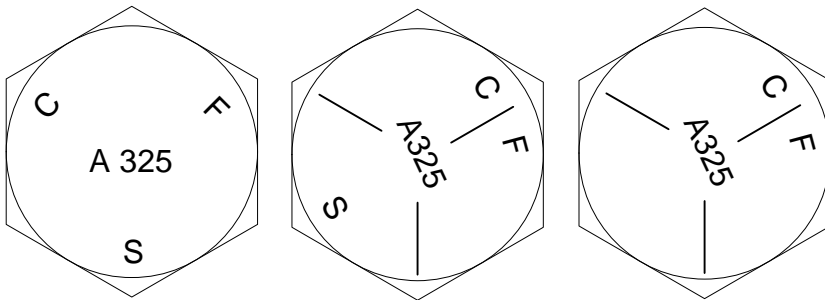

309-01 Cardinal Fastener & Specialty Bedford Heights OH
 Bolt A 354 Gr BD (Grade 8) Gal M/C 67668 6/13/2000 APPR

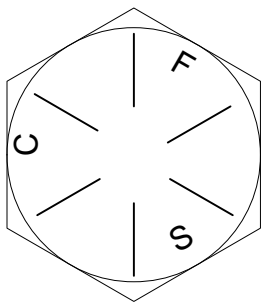

P/S#	P/S Name	City	State	EDate	Status
309-01	Cardinal Fastener & Specialty	Bedford Heights	OH		
Bolt	A 490 Ty 1 Blk	M/C 67619		6/13/2000	APPR

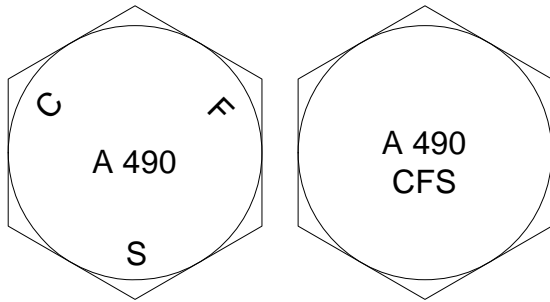

P/S#	P/S Name	City	State	EDate	Status
------	----------	------	-------	-------	--------

6105-01

6105-01	Chicago Fastener Manufacturing	Mokena	IL		
Bolt	A 325 Ty 1 Blk	M/C 65501		5/3/2006	APPR

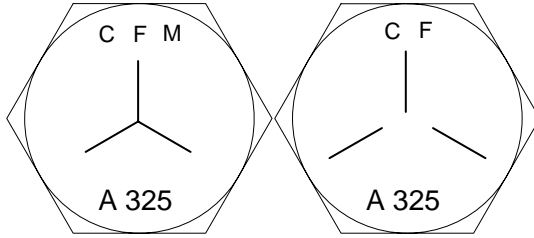

6105-01	Chicago Fastener Manufacturing	Mokena	IL		
Bolt	A 325 Ty 1 Gv	M/C 67616		5/3/2006	APPR

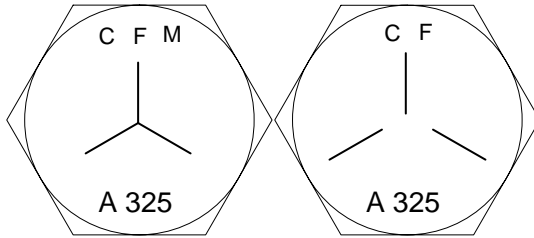

P/S#	P/S Name	City	State	EDate	Status
------	----------	------	-------	-------	--------

4494-01

4494-01 Cold Heading Co. Detroit MI
 Bolt A 449 Blk M/C 67617 12/8/1998 APPR

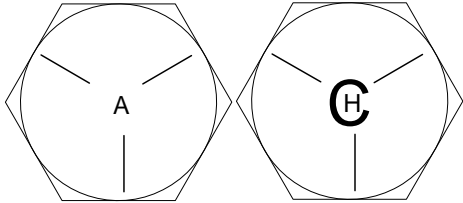

4494-01 Cold Heading Co. Detroit MI
 Bolt A 449 Gv M/C 67618 12/8/1998 APPR

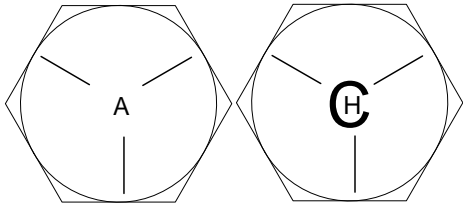

P/S#	P/S Name	City	State	EDate	Status
------	----------	------	-------	-------	--------

5675-01

5675-01 Copper State Bolt & Nut Phoenix AZ
 Bolt A 325 Ty 1 Blk M/C 65501 1/19/2000 APPR

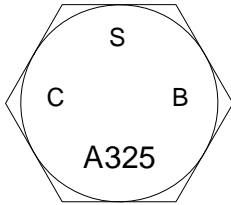

5675-01 Copper State Bolt & Nut Phoenix AZ
 Bolt A 325 Ty 1 Gv M/C 67616 1/19/2000 APPR

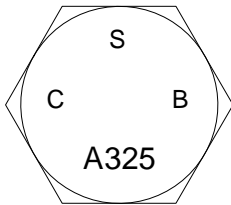

P/S#	P/S Name	City	State	EDate	Status
------	----------	------	-------	-------	--------

4548-01

4548-01	Custom Bolt	Phoenix	AZ		
Bolt	A 307 Gr A/B Blk	M/C 67612		12/8/1998	APPR

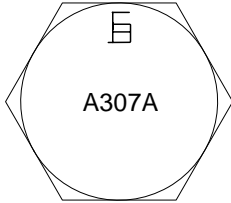

4548-01	Custom Bolt	Phoenix	AZ		
Bolt	A 307 Gr A/B Gv	M/C 67614		12/8/1998	APPR

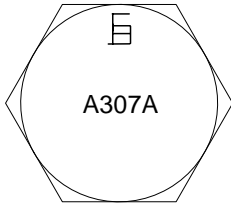

4548-01	Custom Bolt	Phoenix	AZ		
Bolt	A 307 Gr B Blk	M/C 67613		12/8/1998	APPR

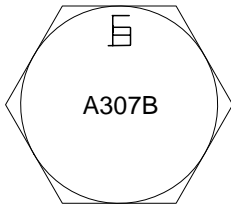

P/S#	P/S Name	City	State	EDate	Status
------	----------	------	-------	-------	--------

4548-01	Custom Bolt	Phoenix	AZ		
Bolt	A 307 Gr B Gv	M/C 67615		12/8/1998	APPR

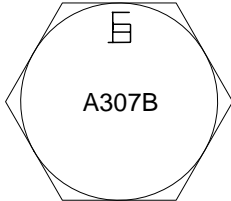

4548-01	Custom Bolt	Phoenix	AZ		
Bolt	A 325 Ty 1 Blk	M/C 65501		12/8/1998	APPR

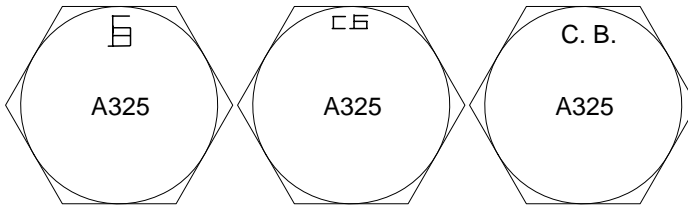

4548-01	Custom Bolt	Phoenix	AZ		
Bolt	A 325 Ty 1 Gv	M/C 67616		12/8/1998	APPR

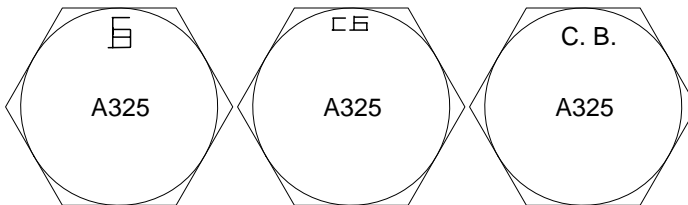

P/S#	P/S Name	City	State	EDate	Status
------	----------	------	-------	-------	--------

4548-01	Custom Bolt	Phoenix	AZ		
Bolt	A 449 Blk	M/C 67617		12/8/1998	APPR

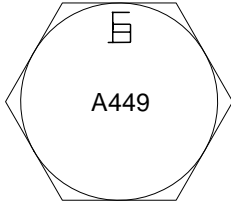

4548-01	Custom Bolt	Phoenix	AZ		
Bolt	A 449 Gv	M/C 67618		12/8/1998	APPR

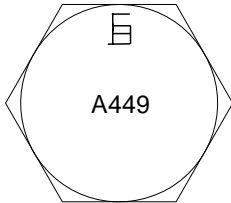

4548-01	Custom Bolt	Phoenix	AZ		
Bolt	A 490 Ty 1 Blk	M/C 67619		12/8/1998	APPR

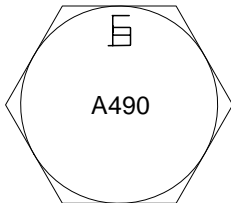

P/S#	P/S Name	City	State	EDate	Status
------	----------	------	-------	-------	--------

4686-01

4686-01 Del-Val Fastener Mfg. Co., Inc Ivyland PA
 Bolt A 193 Gr B8 CL 1 SS M/C 67608 12/8/1998 APPR

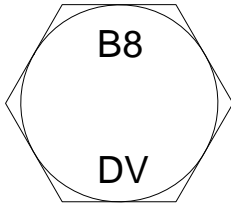

4686-01 Del-Val Fastener Mfg. Co., Inc Ivyland PA
 Bolt A 193 Gr B8 CL 1 SS STD M/C 67623 12/8/1998 APPR

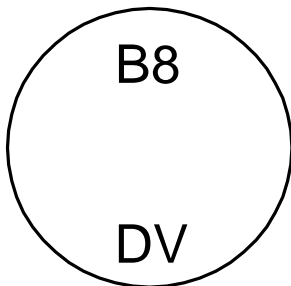

4686-01 Del-Val Fastener Mfg. Co., Inc Ivyland PA
 Bolt A 193 Gr B8 CL 2 SS M/C 67609 12/8/1998 APPR

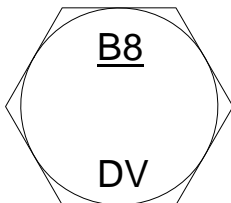

P/S#	P/S Name	City	State	EDate	Status
------	----------	------	-------	-------	--------

4686-01	Del-Val Fastener Mfg. Co., Inc	Ivyland	PA		
Bolt	A 193 Gr B8 CL 2 SS STD	M/C 67624		12/8/1998	APPR

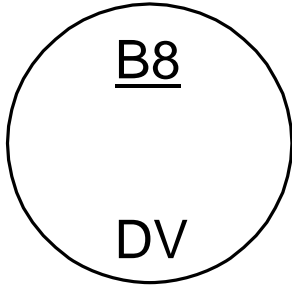

4686-01	Del-Val Fastener Mfg. Co., Inc	Ivyland	PA		
Bolt	A 193 Gr B8M CL 1 SS	M/C 67610		12/8/1998	APPR

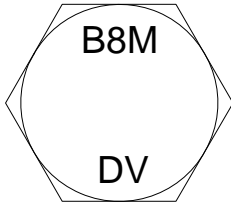

4686-01	Del-Val Fastener Mfg. Co., Inc	Ivyland	PA		
Bolt	A 193 Gr B8M CL 2 SS	M/C 67611		12/8/1998	APPR

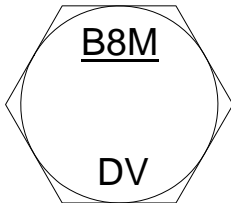

P/S#	P/S Name	City	State	EDate	Status
------	----------	------	-------	-------	--------

3709-01

3709-01 Formed Fasteners Bridgeview IL
 Bolt A 193 Gr B8 CL 1 SS M/C 67608 10/6/1999 APPR

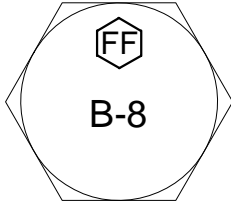

3709-01 Formed Fasteners Bridgeview IL
 Bolt A 193 Gr B8M CL 1 SS M/C 67610 12/8/1998 APPR

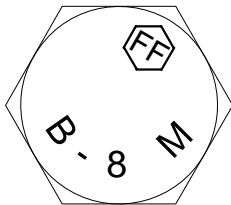

3709-01 Formed Fasteners Bridgeview IL
 Bolt A 307 Gr A/B Blk M/C 67612 7/22/1999 APPR

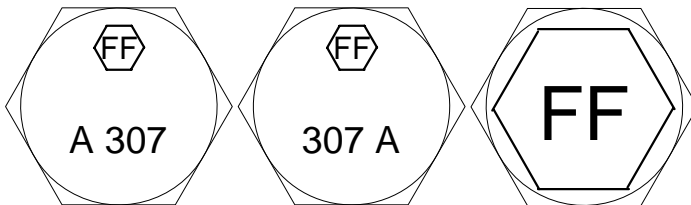

P/S#	P/S Name	City	State	EDate	Status
------	----------	------	-------	-------	--------

3709-01	Formed Fasteners	Bridgeview	IL		
Bolt	A 307 Gr A/B Gv	M/C 67614		7/22/1999	APPR

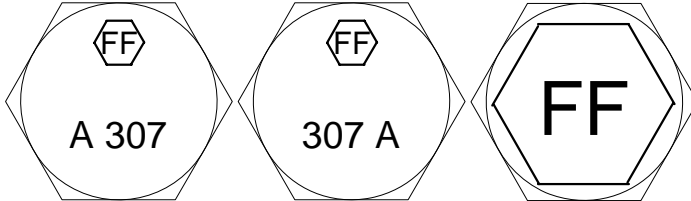

3709-01	Formed Fasteners	Bridgeview	IL		
Bolt	A 307 Gr B Blk	M/C 67613		12/8/1998	APPR

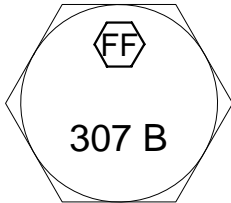

3709-01	Formed Fasteners	Bridgeview	IL		
Bolt	A 307 Gr B Gv	M/C 67615		12/8/1998	APPR

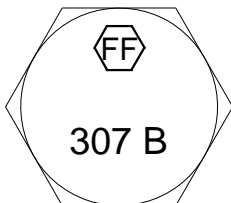

P/S#	P/S Name	City	State	EDate	Status
------	----------	------	-------	-------	--------

3709-01	Formed Fasteners	Bridgeview	IL		
Bolt	A 325 Ty 1 Blk	M/C 65501		12/8/1998	APPR



3709-01	Formed Fasteners	Bridgeview	IL		
Bolt	A 325 Ty 1 Gv	M/C 67616		12/8/1998	APPR



3709-01	Formed Fasteners	Bridgeview	IL		
Bolt	A 325 Ty 3 Blk	M/C 65503		12/8/1998	APPR



P/S#	P/S Name	City	State	EDate	Status
------	----------	------	-------	-------	--------

1594-01

1594-01 Gaffney Bolt & Nut Co. Rockford IL
 Bolt A 307 Gr A/B Blk M/C 67612 12/8/1998 APPR

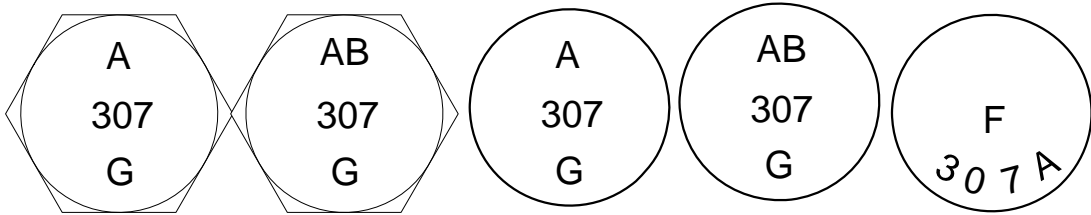

1594-01 Gaffney Bolt & Nut Co. Rockford IL
 Bolt A 307 Gr A/B Gv M/C 67614 12/8/1998 APPR

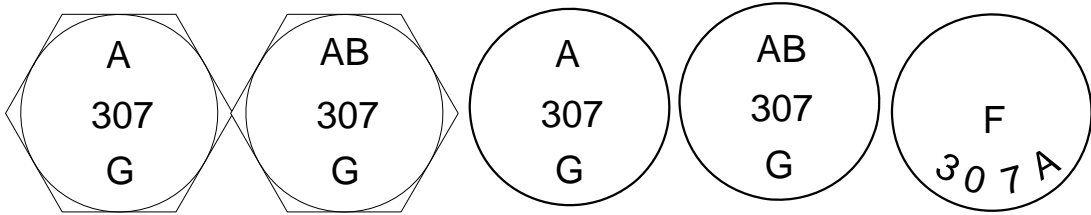

1594-01 Gaffney Bolt & Nut Co. Rockford IL
 Bolt A 325 Ty 1 Blk M/C 65501 6/6/2000 APPR

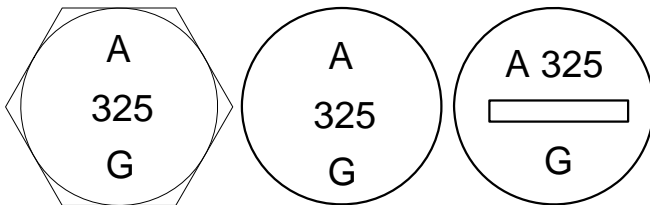

P/S#	P/S Name	City	State	EDate	Status
------	----------	------	-------	-------	--------

1594-01	Gaffney Bolt & Nut Co.	Rockford	IL		
Bolt	A 325 Ty 1 Gv	M/C 67616		6/6/2000	APPR

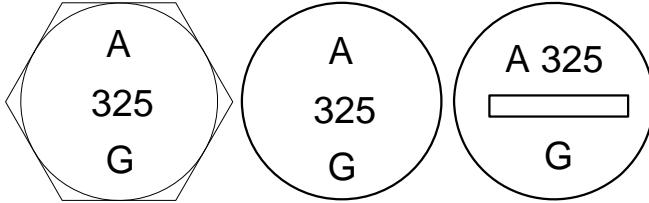

1594-01	Gaffney Bolt & Nut Co.	Rockford	IL		
Bolt	A 449 Blk	M/C 67617		12/8/1998	APPR

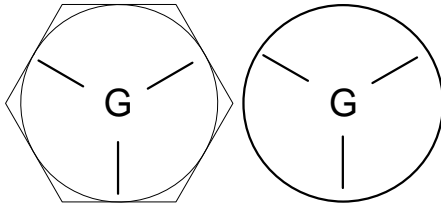

1594-01	Gaffney Bolt & Nut Co.	Rockford	IL		
Bolt	A 449 Gv	M/C 67618		12/8/1998	APPR

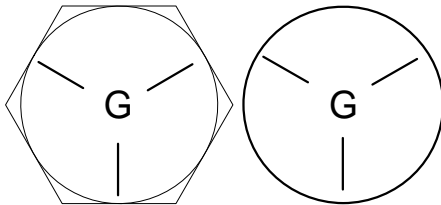

P/S#	P/S Name	City	State	EDate	Status
------	----------	------	-------	-------	--------

3100-01

3100-01	Huck Mfg. Co.	Waco	TX		
Bolt	A 325 Ty 1 Blk	M/C 65501		12/8/1998	APPR

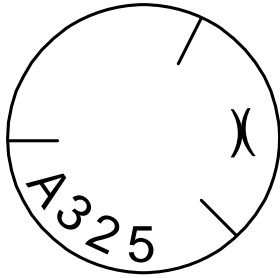

3100-01	Huck Mfg. Co.	Waco	TX		
Bolt	A 325 Ty 1 Gv	M/C 67616		12/8/1998	APPR

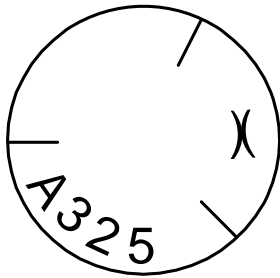

P/S#	P/S Name	City	State	EDate	Status
------	----------	------	-------	-------	--------

1100-01

1100-01 Lake Erie Screw Corp. Cleveland OH
 Bolt A 325 Ty 1 Blk M/C 65501 12/8/1998 APPR

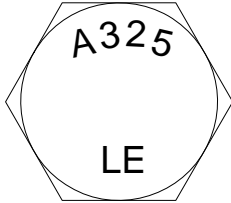

1100-01 Lake Erie Screw Corp. Cleveland OH
 Bolt A 325 Ty 1 Gv M/C 67616 12/8/1998 APPR

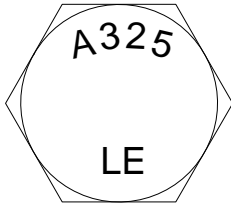

1100-01 Lake Erie Screw Corp. Cleveland OH
 Bolt A 325 Ty 3 Blk M/C 65503 12/8/1998 APPR

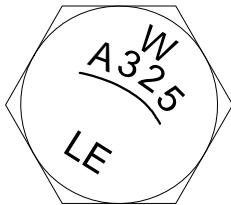

P/S#	P/S Name	City	State	EDate	Status
------	----------	------	-------	-------	--------

1100-01	Lake Erie Screw Corp.	Cleveland	OH		
Bolt	A 449 Blk	M/C 67617		12/8/1998	APPR

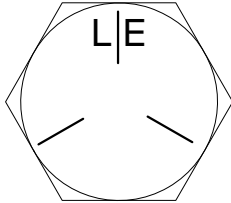

1100-01	Lake Erie Screw Corp.	Cleveland	OH		
Bolt	A 449 Gv	M/C 67618		12/8/1998	APPR

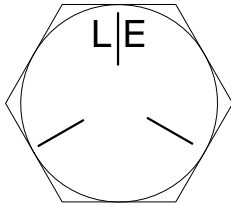

1100-01	Lake Erie Screw Corp.	Cleveland	OH		
Bolt	A 490 Ty 1 Blk	M/C 67619		12/8/1998	APPR



P/S#	P/S Name	City	State	EDate	Status
------	----------	------	-------	-------	--------

4440-01

4440-01	Le Jeune Bolt Co.	Lakeville	MN		
Bolt	A 325 Ty 1 Blk	M/C 65501		12/8/1998	APPR

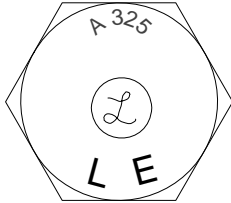

4440-01	Le Jeune Bolt Co.	Lakeville	MN		
Bolt	A 325 Ty 1 Gv	M/C 67616		12/8/1998	APPR

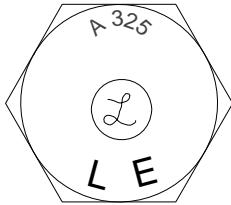

4440-01	Le Jeune Bolt Co.	Lakeville	MN		
Bolt	A 325 Ty 3 Blk	M/C 65503		12/8/1998	APPR

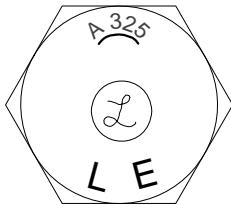

P/S#	P/S Name	City	State	EDate	Status
4440-01	Le Jeune Bolt Co.	Lakeville	MN		
Bolt	A 490 Ty 1 Blk	M/C 67619		12/8/1998	APPR

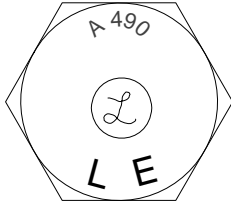

2799-02

2799-02	Lewis Bolt & Nut Co.	La Junta	CO		
Bolt	A 307 Gr A/B Blk/Glv Lag	M/C 67669		5/2/2000	APPR

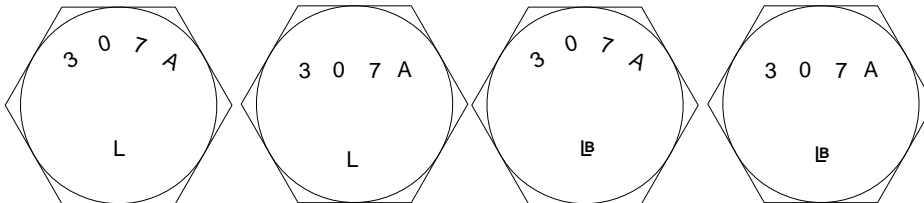

P/S#	P/S Name	City	State	EDate	Status
------	----------	------	-------	-------	--------

1244-01

1244-01 Maryland Bolt & Nut Div. Baltimore MD
 Bolt A 325 Ty 1 Blk M/C 65501 12/8/1998 APPR



Leonard Jed Co.

1244-01 Maryland Bolt & Nut Div. Baltimore MD
 Bolt A 325 Ty 1 Gv M/C 67616 12/8/1998 APPR

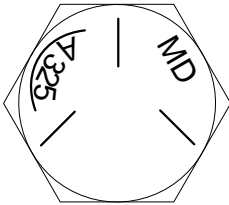

Leonard Jed Co.

1244-01 Maryland Bolt & Nut Div. Baltimore MD
 Bolt A 325 Ty 3 Blk M/C 65503 12/8/1998 APPR

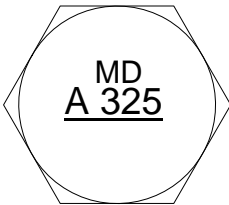

Leonard Jed Co.

P/S#	P/S Name	City	State	EDate	Status
------	----------	------	-------	-------	--------

4397-01

4397-01 Mid-West Fabricating Co. Amanda OH
 Bolt A 307 Gr A/B Blk M/C 67612 12/8/1998 APPR

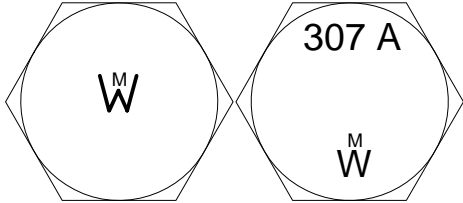

4397-01 Mid-West Fabricating Co. Amanda OH
 Bolt A 307 Gr A/B Gv M/C 67614 12/8/1998 APPR

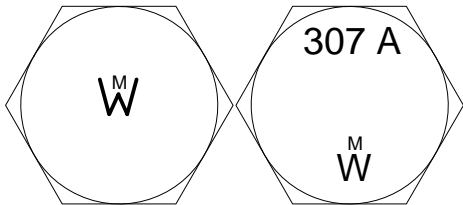

4397-01 Mid-West Fabricating Co. Amanda OH
 Bolt A 307 Gr B Blk M/C 67615 12/8/1998 APPR

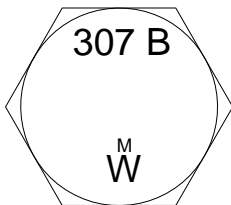

P/S#	P/S Name	City	State	EDate	Status
4397-01	Mid-West Fabricating Co.	Amanda	OH		
Bolt	A 307 Gr B Gv	M/C 67615		12/8/1998	APPR

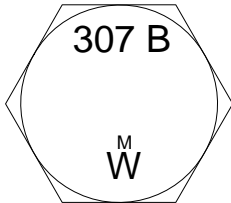

4397-01	Mid-West Fabricating Co.	Amanda	OH		
Bolt	A 307 Rnd Head Gv	M/C 67631		12/8/1998	APPR

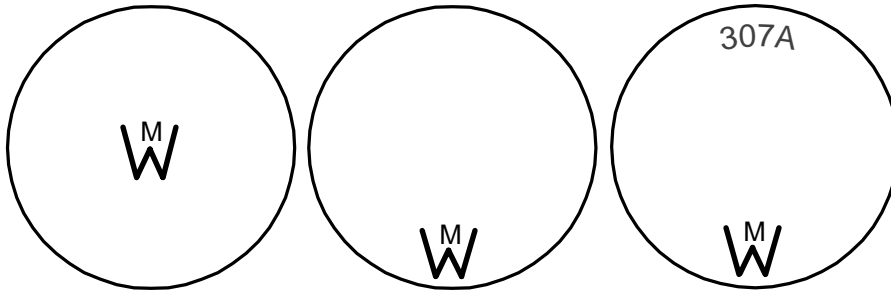

4397-01	Mid-West Fabricating Co.	Amanda	OH		
Bolt	A 325 Ty 1 Blk	M/C 65501		10/3/2008	APPR



P/S#	P/S Name	City	State	EDate	Status
4397-01	Mid-West Fabricating Co.	Amanda	OH		
Bolt	A 325 Ty 1 Gv	M/C 67616		10/3/2008	APPR



P/S#	P/S Name	City	State	EDate	Status
------	----------	------	-------	-------	--------

4619-01

4619-01 MNP Manufacturing Corp. Utica MI
 Bolt A 307 Gr A/B Blk M/C 67612 12/8/1998 APPR

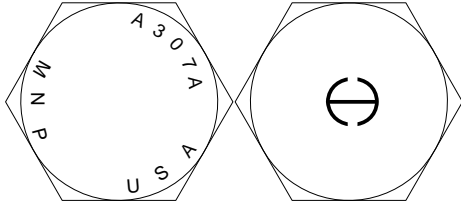

4619-01 MNP Manufacturing Corp. Utica MI
 Bolt A 307 Gr A/B Gv M/C 67614 12/8/1998 APPR

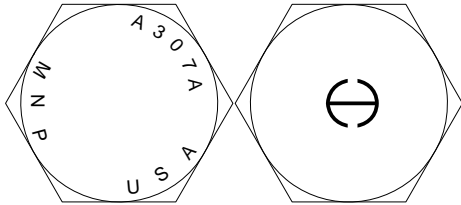

4619-01 MNP Manufacturing Corp. Utica MI
 Bolt A 307 Gr B Blk M/C 67613 12/8/1998 APPR

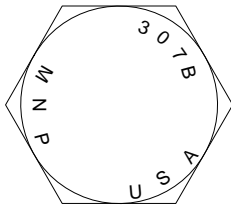

P/S#	P/S Name	City	State	EDate	Status
------	----------	------	-------	-------	--------

4619-01	MNP Manufacturing Corp.	Utica	MI		
Bolt	A 307 Gr B Gv	M/C 67615		12/8/1998	APPR

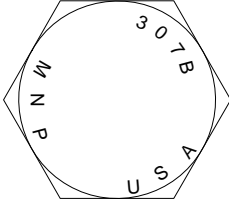

4619-01	MNP Manufacturing Corp.	Utica	MI		
Bolt	A 325 Ty 1 Blk	M/C 65501		12/8/1998	APPR

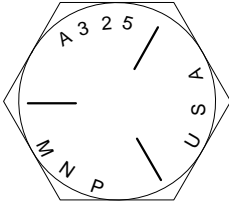

4619-01	MNP Manufacturing Corp.	Utica	MI		
Bolt	A 325 Ty 1 Gv	M/C 67616		12/8/1998	APPR

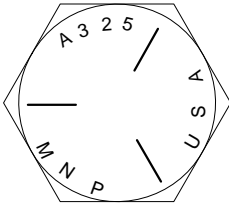

P/S#	P/S Name	City	State	EDate	Status
------	----------	------	-------	-------	--------

2865-01

2865-01	Non-Ferrous Bolt & Mfg.	Las Vegas	NV		
Bolt	A 193 Gr B8 CL 1	M/C 67608		12/8/1998	APPR

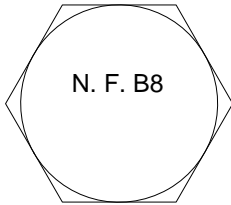

2865-01	Non-Ferrous Bolt & Mfg.	Las Vegas	NV		
Bolt	A 193 Gr B8 CL 2	M/C 67609		12/8/1998	APPR

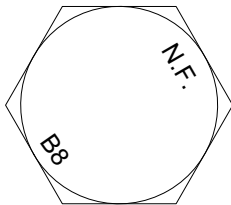

P/S#	P/S Name	City	State	EDate	Status
------	----------	------	-------	-------	--------

4392-01

4392-01	NSS Industries	Plymouth	MI		
Bolt	A 307 Gr A/B Blk	M/C 67612		12/8/1998	APPR



4392-01	NSS Industries	Plymouth	MI		
Bolt	A 307 Gr A/B Gv	M/C 67614		12/8/1998	APPR



4392-01	NSS Industries	Plymouth	MI		
Bolt	A 325 Ty 1 Trq	M/C 65505		12/8/1998	APPR

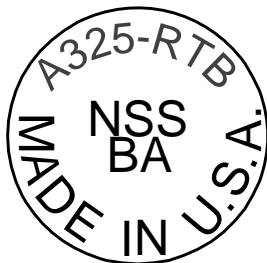

P/S#	P/S Name	City	State	EDate	Status
------	----------	------	-------	-------	--------

2394-05	Nucor Fasteners	St. Joe	IN		
Bolt	A 325 Ty 1 Gv	M/C 67616		5/16/2008	APPR

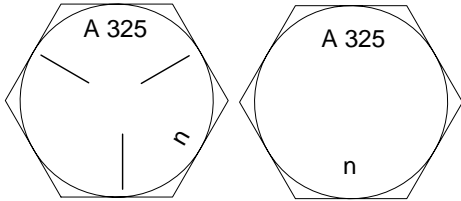

2394-05	Nucor Fasteners	St. Joe	IN		
Bolt	A 325 Ty 3 Blk	M/C 65503		12/8/1998	APPR

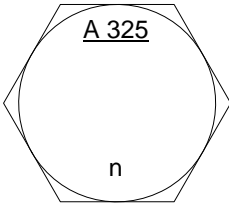

2394-05	Nucor Fasteners	St. Joe	IN		
Bolt	A 449 Blk	M/C 67617		12/8/1998	APPR

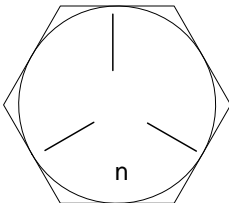

P/S#	P/S Name	City	State	EDate	Status
------	----------	------	-------	-------	--------

2394-05	Nucor Fasteners	St. Joe	IN		
Bolt	A 449 Gv	M/C 67618		12/8/1998	APPR

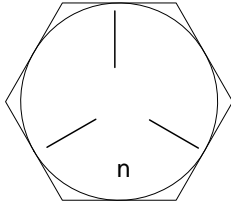

2394-05	Nucor Fasteners	St. Joe	IN		
Bolt	A 490 Ty 1 Blk	M/C 67619		12/8/1998	APPR

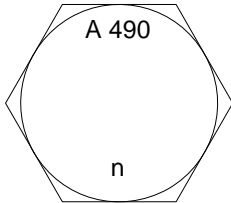

2394-05	Nucor Fasteners	St. Joe	IN		
Bolt	A 490 Ty 3 Blk	M/C 67673		12/8/1998	APPR

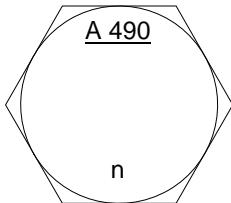

P/S#	P/S Name	City	State	EDate	Status
------	----------	------	-------	-------	--------

4655-01

4655-01 Portland Bolt Co. Portland OR
 Bolt A 307 Gr A/B Blk M/C 67612 12/8/1998 APPR

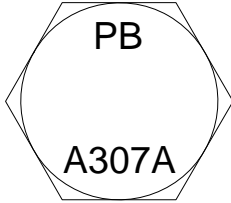

4655-01 Portland Bolt Co. Portland OR
 Bolt A 307 Gr A/B Gv M/C 67614 12/8/1998 APPR

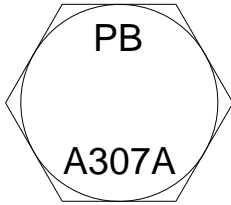

4655-01 Portland Bolt Co. Portland OR
 Bolt A 307 Gr B Blk M/C 67613 12/8/1998 APPR

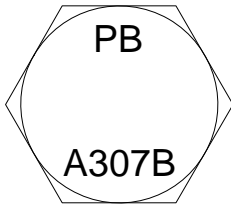

P/S#	P/S Name	City	State	EDate	Status
------	----------	------	-------	-------	--------

4655-01	Portland Bolt Co.	Portland	OR		
Bolt	A 307 Gr B Gv	M/C 67615		12/8/1998	APPR

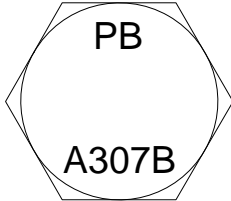

4655-01	Portland Bolt Co.	Portland	OR		
Bolt	A 325 Ty 1 Blk	M/C 65501		12/8/1998	APPR

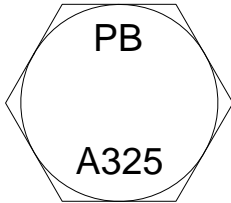

4655-01	Portland Bolt Co.	Portland	OR		
Bolt	A 325 Ty 1 Gv	M/C 67616		12/8/1998	APPR

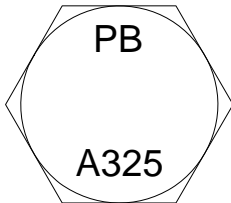

P/S#	P/S Name	City	State	EDate	Status
------	----------	------	-------	-------	--------

4655-01	Portland Bolt Co.	Portland	OR		
Bolt	A 325 Ty 3 Blk	M/C 65503		12/8/1998	APPR

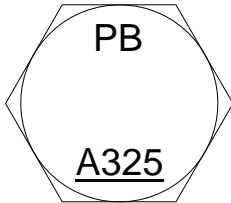

4655-01	Portland Bolt Co.	Portland	OR		
Bolt	A 449 Blk	M/C 67617		12/8/1998	APPR

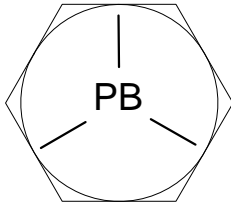

4655-01	Portland Bolt Co.	Portland	OR		
Bolt	A 449 Gv	M/C 67618		12/8/1998	APPR

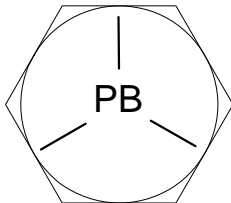

P/S#	P/S Name	City	State	EDate	Status
4655-01	Portland Bolt Co.	Portland	OR		
Bolt	A 490 Ty 1 Blk	M/C 67619		12/8/1998	APPR

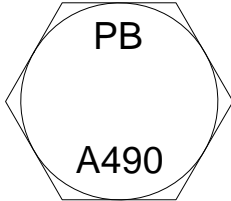

P/S#	P/S Name	City	State	EDate	Status
------	----------	------	-------	-------	--------

3886-01

3886-01 ProFast Mfg. Corp. Mokena IL
 Bolt A 307 Gr A/B Blk M/C 67612 12/8/1998 APPR

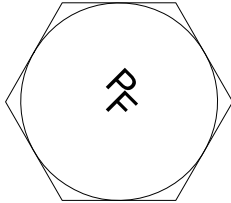

3886-01 ProFast Mfg. Corp. Mokena IL
 Bolt A 307 Gr A/B Gv M/C 67614 12/8/1998 APPR

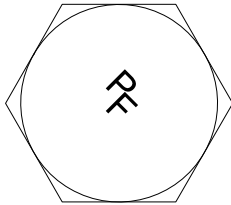

3886-01 ProFast Mfg. Corp. Mokena IL
 Bolt A 325 Ty 1 Blk M/C 65501 12/8/1998 APPR

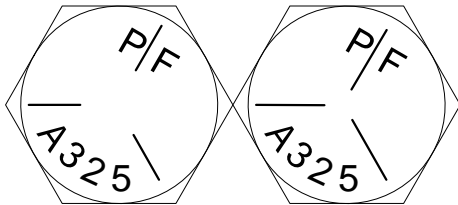

P/S#	P/S Name	City	State	EDate	Status
------	----------	------	-------	-------	--------

3886-01	ProFast Mfg. Corp.	Mokena	IL		
Bolt	A 325 Ty 1 Gv	M/C 67616		12/8/1998	APPR

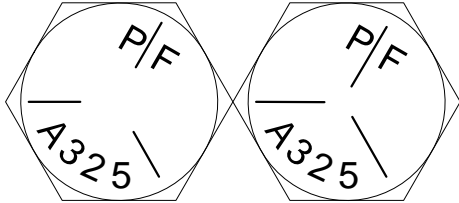

3886-01	ProFast Mfg. Corp.	Mokena	IL		
Bolt	A 325 Ty 3 Blk	M/C 65503		12/8/1998	APPR



3886-01	ProFast Mfg. Corp.	Mokena	IL		
Bolt	A 449 Blk	M/C 67617		12/8/1998	APPR

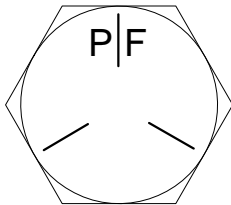

P/S#	P/S Name	City	State	EDate	Status
3886-01	ProFast Mfg. Corp.	Mokena	IL		
Bolt	A 449 Gv	M/C 67618		12/8/1998	APPR

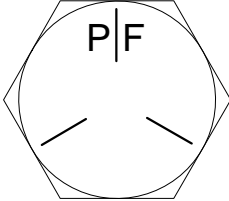

3886-01	ProFast Mfg. Corp.	Mokena	IL		
Bolt	A 490 Ty 1 Blk	M/C 67619		12/8/1998	APPR



P/S#	P/S Name	City	State	EDate	Status
------	----------	------	-------	-------	--------

4438-01

4438-01 Robbins Mfg. Co., Inc. Fall River MA
 Bolt A 193 Gr B8 CL 1 SS M/C 67608 12/8/1998 APPR

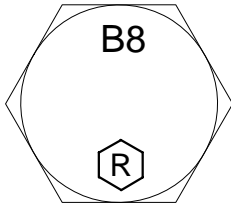

4438-01 Robbins Mfg. Co., Inc. Fall River MA
 Bolt A 193 Gr B8M CL 1 SS M/C 67610 12/8/1998 APPR

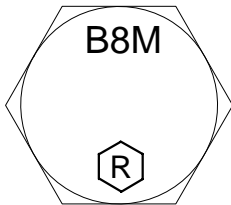

P/S#	P/S Name	City	State	EDate	Status
------	----------	------	-------	-------	--------

4318-01

4318-01 Rockford Bolt & Steel Company Rockford IL
 Bolt A 307 Gr A/B Blk M/C 67612 12/8/1998 APPR

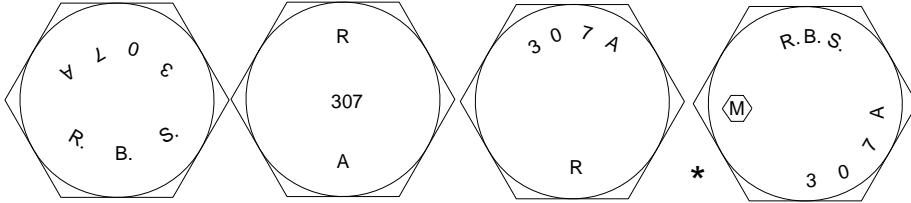

* Produced for Rockford Bolt by MNP corp. P/S# 4619-01

4318-01 Rockford Bolt & Steel Company Rockford IL
 Bolt A 307 Gr A/B Gv M/C 67614 12/8/1998 APPR

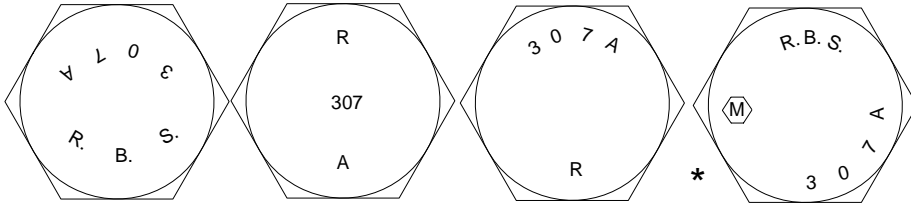

* Produced for Rockford Bolt by MNP corp. P/S# 4619-01

4318-01 Rockford Bolt & Steel Company Rockford IL
 Bolt A 307 Rnd Head Gv M/C 67631 4/3/2000 APPR

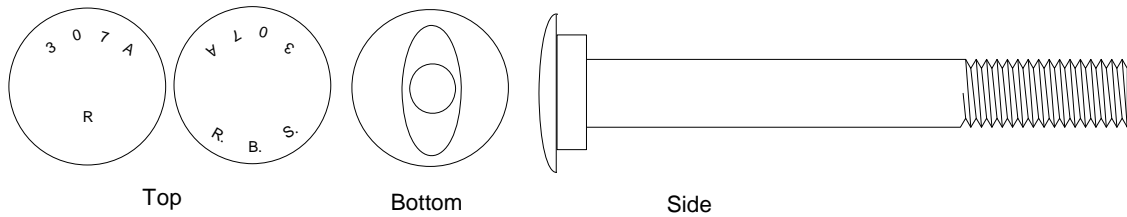

P/S#	P/S Name	City	State	EDate	Status
------	----------	------	-------	-------	--------

4318-01	Rockford Bolt & Steel Company	Rockford	IL		
Bolt	A 307 Sqr Head Blk	M/C 67612		12/8/1998	APPR

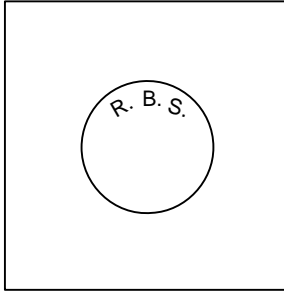

4318-01	Rockford Bolt & Steel Company	Rockford	IL		
Bolt	A 307 Sqr Head Gv	M/C 67614		12/8/1998	APPR

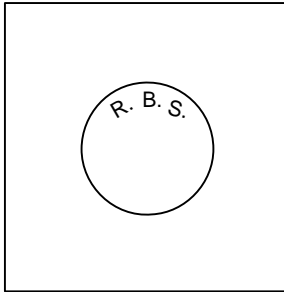

4318-01	Rockford Bolt & Steel Company	Rockford	IL		
Bolt	A 325 Ty 1 Blk	M/C 67616		8/17/2000	APPR

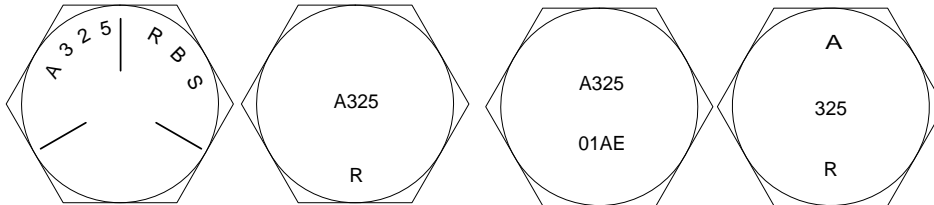

P/S#	P/S Name	City	State	EDate	Status
------	----------	------	-------	-------	--------

4318-01	Rockford Bolt & Steel Company	Rockford	IL		
Bolt	A 325 Ty 1 Gv	M/C 67616		8/17/2000	APPR

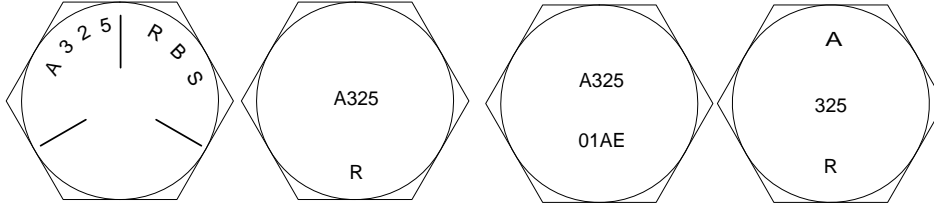

4318-01	Rockford Bolt & Steel Company	Rockford	IL		
Bolt	A 449 Blk	M/C 67617		12/8/1998	APPR

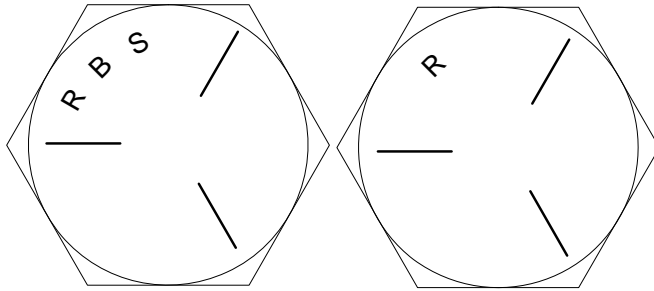

4318-01	Rockford Bolt & Steel Company	Rockford	IL		
Bolt	A 449 Gv	M/C 67618		12/8/1998	APPR

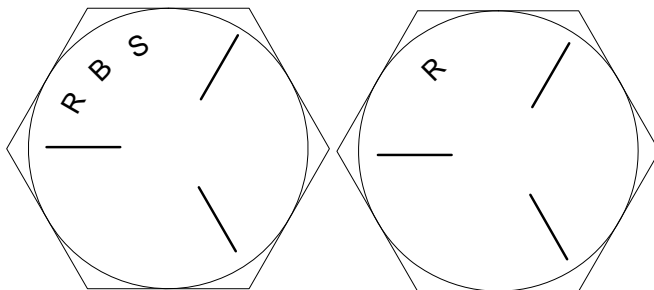

P/S#	P/S Name	City	State	EDate	Status
------	----------	------	-------	-------	--------

4612-01

4612-01 Silo Fastener, Inc. Kansas City MO
 Bolt A 307 Gr A/B Blk M/C 67612 5/3/2006 APPR

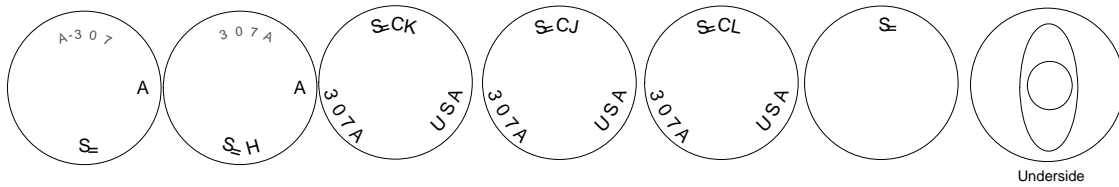

4612-01 Silo Fastener, Inc. Kansas City MO
 Bolt A 307 Gr A/B Gv M/C 67614 5/3/2006 APPR

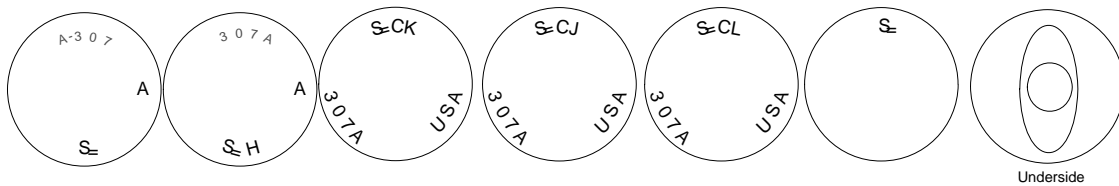

4612-01 Silo Fastener, Inc. Kansas City MO
 Bolt A 307 Gr B Blk M/C 67613 12/8/1998 APPR

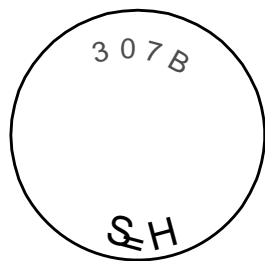

P/S#	P/S Name	City	State	EDate	Status
4612-01	Silo Fastener, Inc.	Kansas City	MO		
Bolt	A 307 Gr B Gv	M/C 67615		12/8/1998	APPR

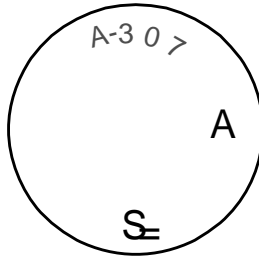
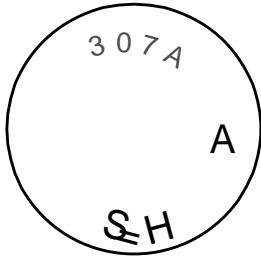

P/S#	P/S Name	City	State	EDate	Status
------	----------	------	-------	-------	--------

1810-01

1810-01	Southwestern Bolt & Screw	Birmingham	AL		
Bolt	A 307 Gr A/B Blk	M/C 67612		12/8/1998	APPR

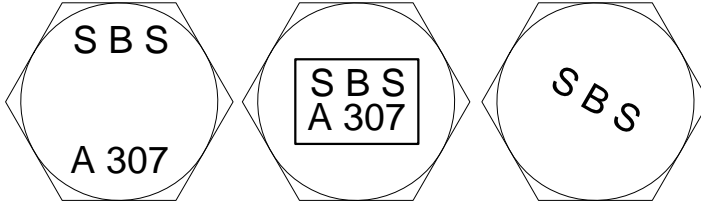

1810-01	Southwestern Bolt & Screw	Birmingham	AL		
Bolt	A 307 Gr A/B Gv	M/C 67614		12/8/1998	APPR

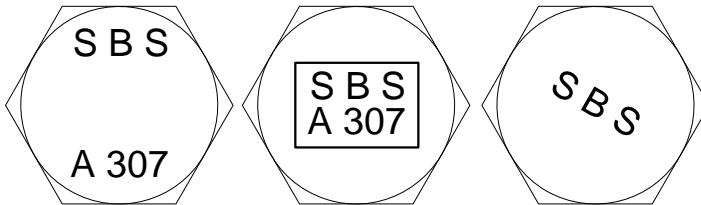

P/S#	P/S Name	City	State	EDate	Status
------	----------	------	-------	-------	--------

1728-01

1728-01 St. Louis Screw & Bolt Co. St. Louis MO
 Bolt A 307 Gr A/B Blk M/C 67612 12/8/1998 APPR

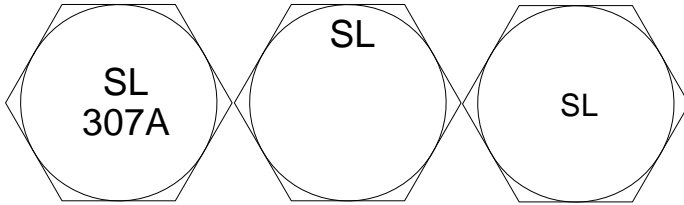

1728-01 St. Louis Screw & Bolt Co. St. Louis MO
 Bolt A 307 Gr A/B Gv M/C 67614 12/8/1998 APPR

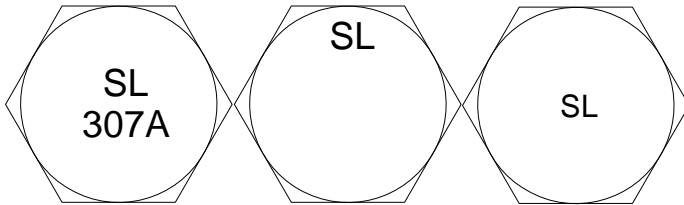

1728-01 St. Louis Screw & Bolt Co. St. Louis MO
 Bolt A 307 Gr B Blk M/C 67613 12/8/1998 APPR

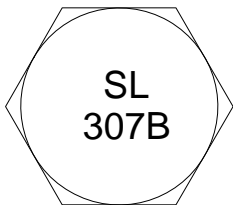

P/S#	P/S Name	City	State	EDate	Status
1728-01	St. Louis Screw & Bolt Co.	St. Louis	MO		
Bolt	A 307 Gr B Gv	M/C 67615		12/8/1998	APPR

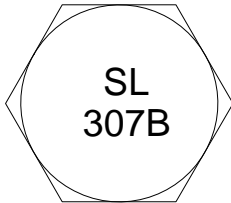

1728-01	St. Louis Screw & Bolt Co.	St. Louis	MO		
Bolt	A 325 Ty 1 Blk	M/C 65501		5/3/2006	APPR



* Producer by Lake Erie Screw Corp (P/S#1100-01) for St. Louis Screw & Bolt

1728-01	St. Louis Screw & Bolt Co.	St. Louis	MO		
Bolt	A 325 Ty 1 Gv	M/C 67616		5/3/2006	APPR



* Producer by Lake Erie Screw Corp (P/S#1100-01) for St. Louis Screw & Bolt

P/S#	P/S Name	City	State	EDate	Status
------	----------	------	-------	-------	--------

1728-01	St. Louis Screw & Bolt Co.	St. Louis	MO		
Bolt	A 325 Ty 3 Blk	M/C 65503		10/3/2008	APPR

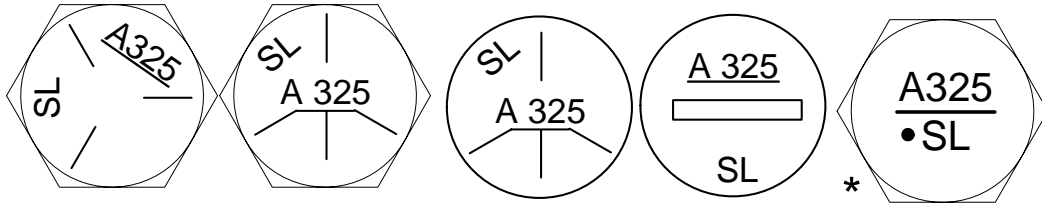

* Producer by Lake Erie Screw Corp (P/S#1100-01) for St. Louis Screw & Bolt

1728-01	St. Louis Screw & Bolt Co.	St. Louis	MO		
Bolt	A 449 Blk	M/C 67617		12/8/1998	APPR

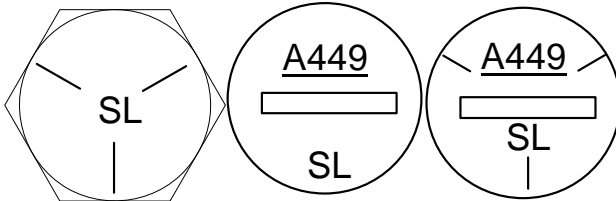

1728-01	St. Louis Screw & Bolt Co.	St. Louis	MO		
Bolt	A 449 Gv.	M/C 67618		12/8/1998	APPR

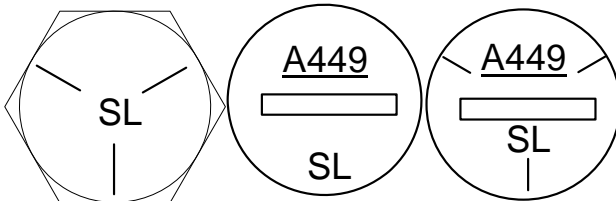

P/S#	P/S Name	City	State	EDate	Status
1728-01	St. Louis Screw & Bolt Co.	St. Louis	MO		
Bolt	A 490 Ty 1 Blk	M/C 67619		1/19/2000	APPR



P/S#	P/S Name	City	State	EDate	Status
------	----------	------	-------	-------	--------

2984-01

2984-01 Standard Bolt & Nut Co. Cumberland RI
 Bolt A 193 Gr B8 CL 1 SS M/C 67608 5/3/2006 APPR

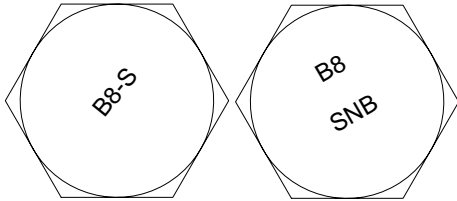

2984-01 Standard Bolt & Nut Co. Cumberland RI
 Bolt A 193 Gr B8 CL 1 SS STD M/C 67623 12/8/1998 APPR

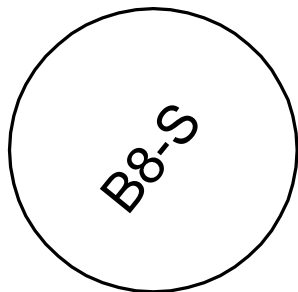

P/S#	P/S Name	City	State	EDate	Status
------	----------	------	-------	-------	--------

1849-01

1849-01 Steel City Bolt & Screw Birmingham AL
 Bolt A 307 Gr A/B Blk M/C 67612 12/8/1998 APPR

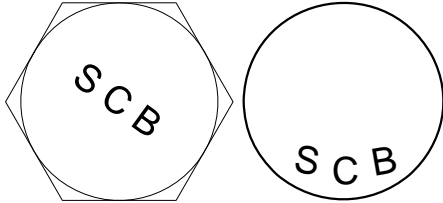

1849-01 Steel City Bolt & Screw Birmingham AL
 Bolt A 307 Gr A/B Gv M/C 67614 12/8/1998 APPR

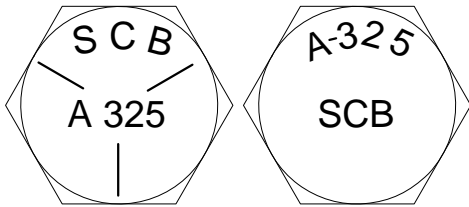

1849-01 Steel City Bolt & Screw Birmingham AL
 Bolt A 325 Ty 1 Blk M/C 65501 12/8/1998 APPR

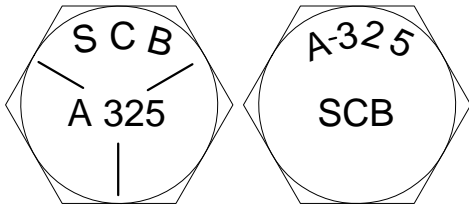

P/S#	P/S Name	City	State	EDate	Status
1849-01	Steel City Bolt & Screw	Birmingham	AL		
Bolt	A 325 Ty 1 Gv	M/C 67616		12/8/1998	APPR

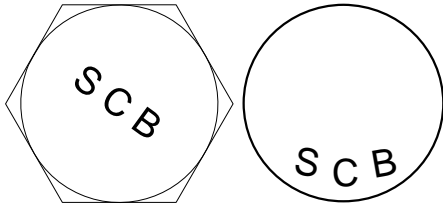

P/S#	P/S Name	City	State	EDate	Status
------	----------	------	-------	-------	--------

1911-01

1911-01 Texas Bolt Company Houston TX
 Bolt A 193 Gr B8 CL 1 M/C 67608 12/8/1998 APPR

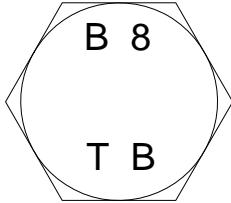

1911-01 Texas Bolt Company Houston TX
 Bolt A 193 Gr B8 CL 2 M/C 67609 12/8/1998 APPR

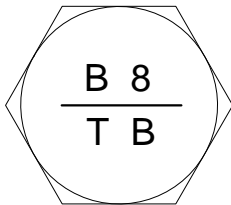

1911-01 Texas Bolt Company Houston TX
 Bolt A 325 Ty 1 Blk M/C 65501 12/8/1998 APPR

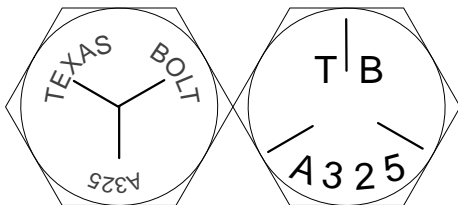

P/S#	P/S Name	City	State	EDate	Status
------	----------	------	-------	-------	--------

1911-01	Texas Bolt Company	Houston	TX		
Bolt	A 325 Ty 1 Gv	M/C 67616		12/8/1998	APPR

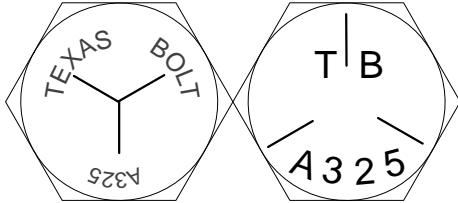

1911-01	Texas Bolt Company	Houston	TX		
Bolt	A 490 Ty 1 Blk	M/C 67619		12/8/1998	APPR

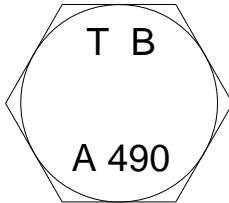

P/S#	P/S Name	City	State	EDate	Status
------	----------	------	-------	-------	--------

2214-03

2214-03 Trinity Industries, Inc. Lima, OH
 Bolt A 307 Gr A/B Blk M/C 67612 5/3/2006 APPR

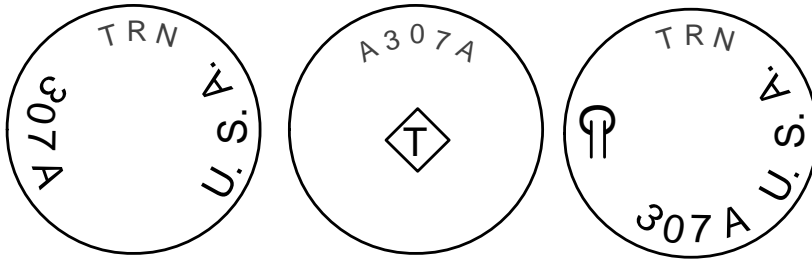

2214-03 Trinity Industries, Inc. Lima, OH
 Bolt A 307 Gr A/B Gv M/C 67614 5/3/2006 APPR

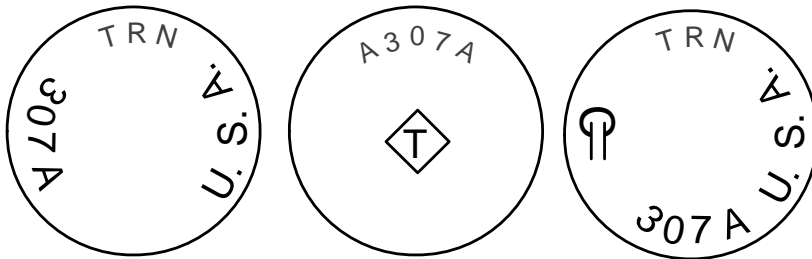

2214-03 Trinity Industries, Inc. Lima, OH
 Bolt A 307 Gr B Blk M/C 67613 12/8/1998 APPR

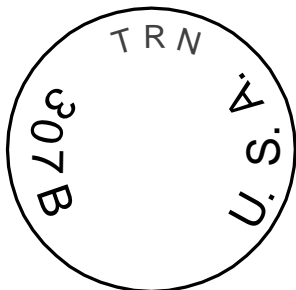

P/S#	P/S Name	City	State	EDate	Status
2214-03	Trinity Industries, Inc.	Lima,	OH		
Bolt	A 307 Gr B Gv	M/C 67615		12/8/1998	APPR

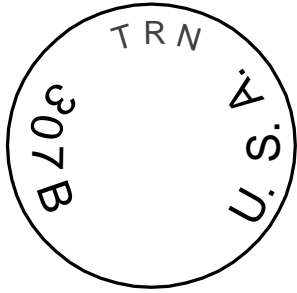

P/S#	P/S Name	City	State	EDate	Status
------	----------	------	-------	-------	--------

2010-02

2010-02 Unytite, Inc. Peru IL
 Bolt A 325 Ty 1 Blk M/C 65501 12/8/1998 APPR

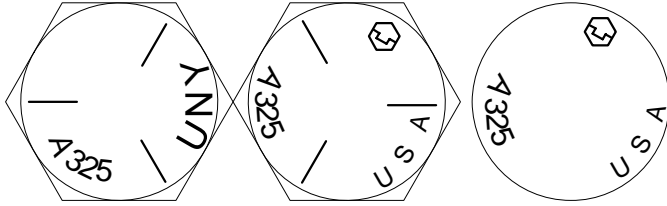

2010-02 Unytite, Inc. Peru IL
 Bolt A 325 Ty 1 Gv M/C 67616 12/8/1998 APPR

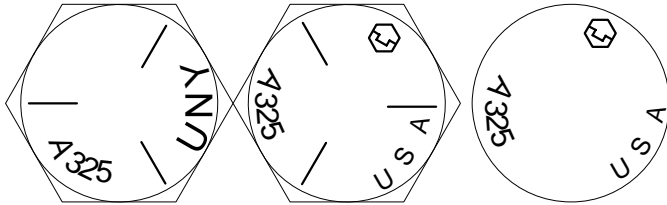

2010-02 Unytite, Inc. Peru IL
 Bolt A 325 Ty 3 Blk M/C 65503 12/8/1998 APPR

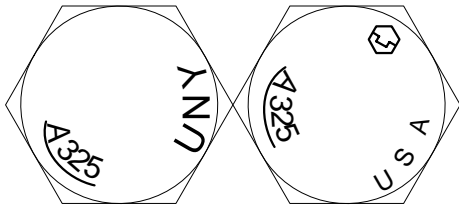

P/S#	P/S Name	City	State	EDate	Status
------	----------	------	-------	-------	--------

6075-01

6075-01	Vegas Fastener Manufacturing	Las Vegas	NV		
Bolt	A 193 Gr B8 CL 1 SS	M/C 67608		10/3/2008	APPR

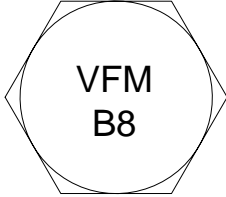

P/S#	P/S Name	City	State	EDate	Status
------	----------	------	-------	-------	--------

5634-01

5634-01 Vermont Fastener Manufacturing Swanton VT
 Bolt A 307 Gr A/B Blk M/C 67612 4/9/1999 APPR

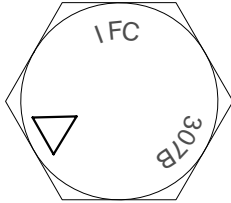

Fastener must have the "IFC" logo with the triangle to be of domestic origin.

5634-01 Vermont Fastener Manufacturing Swanton VT
 Bolt A 307 Gr A/B Gv M/C 67614 4/9/1999 APPR

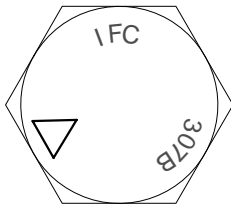

Fastener must have the "IFC" logo with the triangle to be of domestic origin.

5634-01 Vermont Fastener Manufacturing Swanton VT
 Bolt A 325 Ty 1 Blk M/C 65501 4/9/1999 APPR

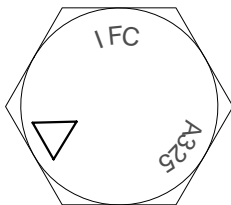

Fastener must have the "IFC" logo with the triangle to be of domestic origin.

P/S#	P/S Name	City	State	EDate	Status
------	----------	------	-------	-------	--------

5634-01	Vermont Fastener Manufacturing	Swanton	VT		
Bolt	A 325 Ty 1 Gv	M/C 67616		4/9/1999	APPR

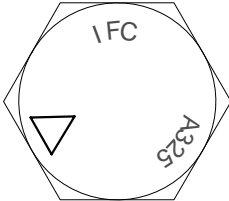

Fastener must have the "IFC" logo with the triangle to be of domestic origin.

5634-01	Vermont Fastener Manufacturing	Swanton	VT		
Bolt	A 325 Ty 3 Blk	M/C 65503		4/9/1999	APPR

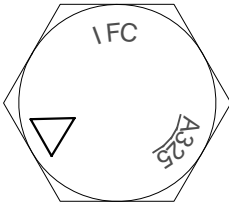

Fastener must have the "IFC" logo with the triangle to be of domestic origin.

5634-01	Vermont Fastener Manufacturing	Swanton	VT		
Bolt	A 490 Ty 1 Blk	M/C 67619		4/9/1999	APPR

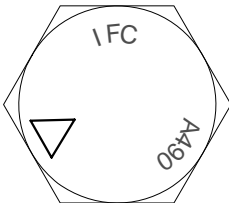

Fastener must have the "IFC" logo with the triangle to be of domestic origin.

P/S#	P/S Name	City	State	EDate	Status
5634-01	Vermont Fastener Manufacturing	Swanton	VT		
Bolt	A 490 Ty 3 Blk	M/C 67673		4/9/1999	APPR

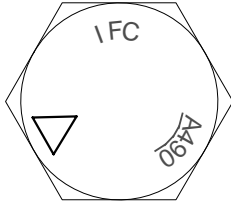

Fastener must have the "IFC" logo with the triangle to be of domestic origin.

P/S#	P/S Name	City	State	EDate	Status
------	----------	------	-------	-------	--------

2049-01

2049-01 Vulcan Rivet & Bolt Corp. Birmingham AL
 Bolt A 307 Gr A/B Blk M/C 67612 12/8/1998 APPR

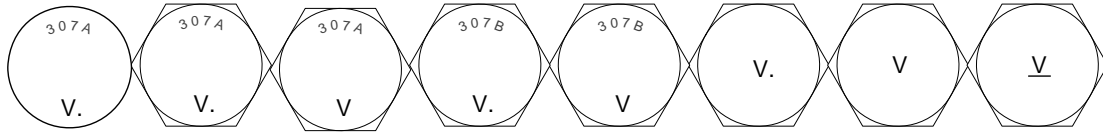

2049-01 Vulcan Rivet & Bolt Corp. Birmingham AL
 Bolt A 307 Gr A/B Gv M/C 67614 12/8/1998 APPR

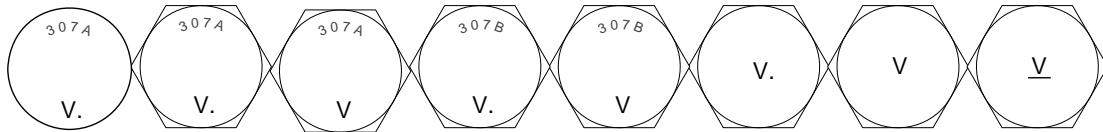

2049-01 Vulcan Rivet & Bolt Corp. Birmingham AL
 Bolt A 325 Ty 1 Blk M/C 65501 12/8/1998 APPR

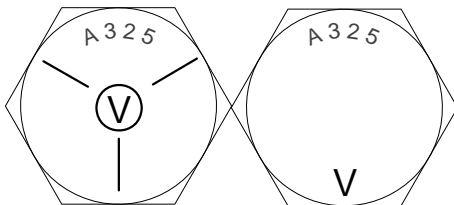

Fasteners - Studs

01-Oct-08

P/S#	P/S Name	City	State	EDate	Status
------	----------	------	-------	-------	--------

2233-01

2233-01	Erico Fastening System	Moorestown	NJ		
Stud	Stud Shear Connector	M/C 65801	12/8/1998	APPR	

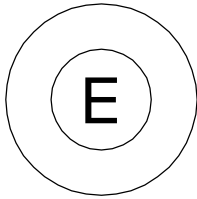

2233-02

2233-02	Erico Fastening Systems	Cleveland	OH		
Stud	Stud Shear Connector	M/C 65801	12/8/1998	APPR	

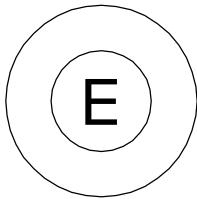

P/S#	P/S Name	City	State	EDate	Status
------	----------	------	-------	-------	--------

1423-03

1423-03	Nelson Stud Welding Div	Irving	TX		
Stud	Stud Sheer Connector	M/C 65801	12/8/1998	APPR	

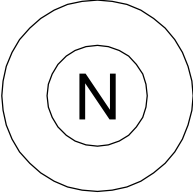

1423-01

1423-01	Nelson Stud Welding Div.	Bridgeview	IL		
Stud	Stud Sheer Connector	M/C 65801	12/8/1998	APPR	

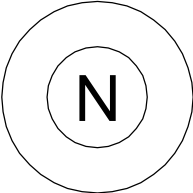

P/S#	P/S Name	City	State	EDate	Status
------	----------	------	-------	-------	--------

1423-02

1423-02	Nelson Stud Welding Div.	Lorain	OH		
Stud	Stud Shear Connector	M/C 65801	12/8/1998	APPR	

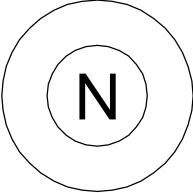

4392-01

4392-01	NSS Industries	Plymouth	MI		
Stud	Stud Shear Connector	M/C 65801	12/8/1998	APPR	

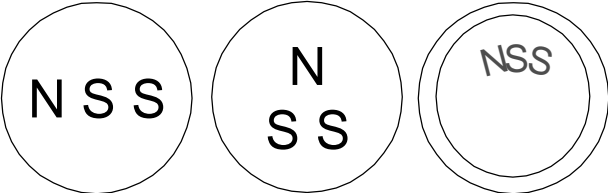

P/S#	P/S Name	City	State	EDate	Status
------	----------	------	-------	-------	--------

4273-01

4273-01	Stud Welding Associates	Elyria	OH		
Stud	Stud Sheer Connector	M/C 65801		6/9/1999	APPR

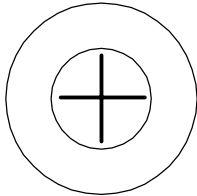

1964-01

1964-01	Tru-Fit Prods. Corp.	Medina	OH		
Stud	Stud Shear Connector	M/C 65801		12/8/1998	APPR

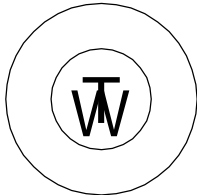

INSTRUCTIONS FOR IDENTIFICATION OF NUTS

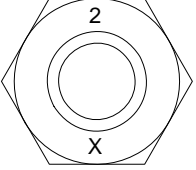
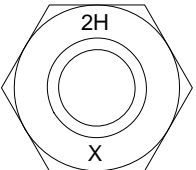
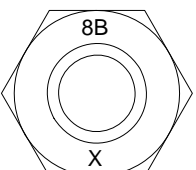
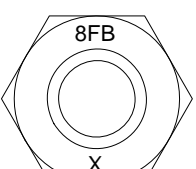
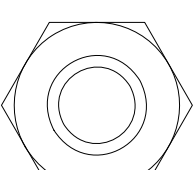
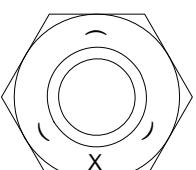
SPECIFICATION AND MATERIAL CODES	GRADE MARKING	REQUIRED MARKINGS
ASTM A 194 Grade 2 Heavy Series 65601 Galv. 67703 Lock 67701 Galv. Lock 67705		Symbol for identification of grade, i.e., "2".. Manufacturer's identification mark, e.g., "2".
ASTM A 194 Grade 2H Heavy Series 65602 Galv. 67704 Lock 67702 Galv. Lock 67706		Symbol for identification of grade, i.e., "2H". ("H" means nut was heat-treated.) Manufacturer's identification mark, e.g., "X".
ASTM A 194 Grade 8 Type B Regular Series and Heavy Series 67707 Lock 67709		Symbol for identification of grade and type i.e., "8B". ("B" means nut was machined from bar stock.) Manufacturer's identification mark, e.g., "X".
ASTM A 194 Grade 8F Type B Regular Series and Heavy Series 67708 Lock 67710		Symbol for identification of grade and type, i.e., "8FB". ("B" means nut was machined from bar stock.) Manufacturer's identification mark, e.g., "X".
ASTM A563 Grade A Regular Series and Heavy Series 67728 Galv. 67729 Lock 67730 Galv. Lock 67730 Cad. Plated 67725		No required identification mark..
ASTM A 563 Grade C Heavy Series 65603 Galv. 67711 Lock 67712 Galv. Lock 67712		Three equally spaced circumferential lines on one face. Manufacturer's identification mark, e.g., "X". Markings depressed if applied to bearing surface.

Typical:

Nut Sleeve--67723

Stain. Steel--67731

Stain. Steel Lock--67732

INSTRUCTIONS FOR IDENTIFICATION OF NUTS

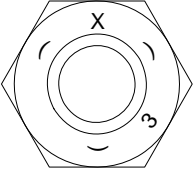
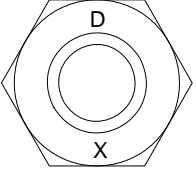
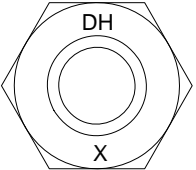
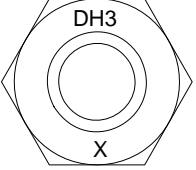
SPECIFICATION AND MATERIAL CODES	GRADE MARKING	REQUIRED MARKINGS
ASTM A 563 Grade C3 Heavy Series 65604 Galv. 67733 Lock 65607		Three equally spaced circumferential lines on one face. "3" on one face Other distinguishing marks indicating nut is atmospheric corrosion resistant and of a weathering type on one face (at option of manufacturer). Manufacturer's identification mark, e.g., "X". Markings depressed if applied to bearing surface.
ASTM A 563 Grade D Heavy Series 65605 Galv. 67716 Lock 67718 Galv. Lock 67720		Symbol for identification of grade, i.e., "D", on one face. Manufacturer's identification mark, e.g., "X". Markings depressed if applied to bearing surface.
ASTM A 563 Grade DH Heavy Series 65606 Galv. 67717 Lock 67719 Galv. Lock 67721		Symbol for identification of grade, i.e., "DH", on one face. Manufacturer's identification mark, e.g., "X". Markings depressed if applied to bearing surface.
ASTM A 563 Grade DH3 Heavy Series 67734		Symbol for identification of grade, i.e., "DH3", on one face. Other distinguishing marks indicating nut is atmospheric corrosion resistant and of a weathering type on one face (at option of manufacturer). Manufacturer's identification mark, e.g., "X". Markings depressed if applied to bearing surface.

Typical:

Nut Sleeve--67723

Stain. Steel--67731

Stain. Steel Lock--67732

Fasteners - Nuts

01-Oct-08

P/S#	P/S Name	City	State	EDate	Status
------	----------	------	-------	-------	--------

4505-01

4505-01	A & G Engineering Co.	Anaheim	CA		
Nut	A 194 Gr 2H Hvy Series Blk	M/C 65602	12/8/1998	APPR	

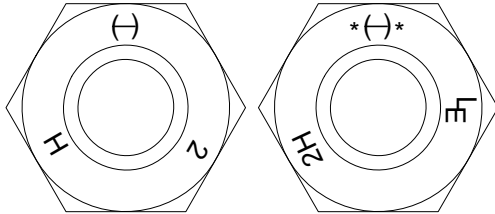

4505-01	A & G Engineering Co.	Anaheim	CA		
Nut	A 194 Gr 2H Hvy Series Gv	M/C 67704	12/8/1998	APPR	

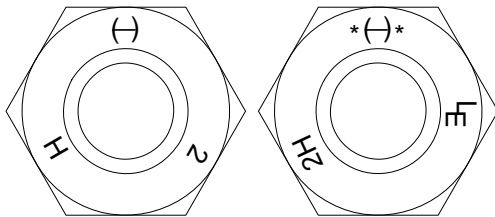

P/S#	P/S Name	City	State	EDate	Status
------	----------	------	-------	-------	--------

3538-01

3538-01	Daniel Industries	Houston	TX		
Nut	A 194 Gr 2 Hvy Series Gv	M/C 67703		12/8/1998	APPR

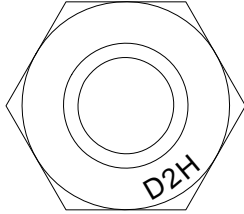

3538-01	Daniel Industries	Houston	TX		
Nut	A 194 Gr 2H Hvy Series Blk	M/C 65602		12/8/1998	APPR

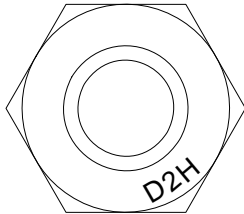

P/S#	P/S Name	City	State	EDate	Status
------	----------	------	-------	-------	--------

499-01

499-01 Decker Mfg. Corp. Albion MI
 Nut A 563 Gr A Reg & Hvy Series Blk M/C 67728 3/27/2000 APPR

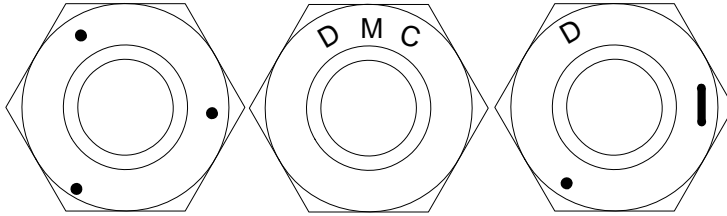

499-01 Decker Mfg. Corp. Albion MI
 Nut A 563 Gr A Reg & Hvy Series Gv M/C 67729 3/27/2000 APPR

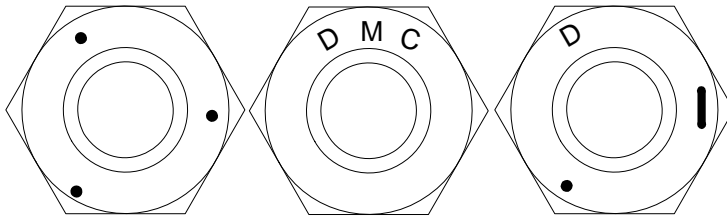

499-01 Decker Mfg. Corp. Albion MI
 Nut A 563 Gr C Hvy Series Blk M/C 65603 12/8/1998 APPR

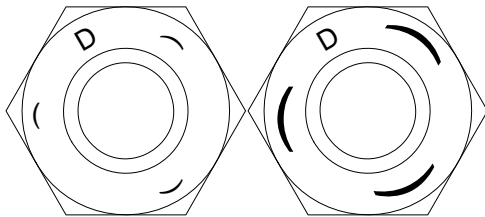

P/S#	P/S Name	City	State	EDate	Status
499-01	Decker Mfg. Corp.	Albion	MI		
Nut	A 563 Gr C Hvy Series Gv	M/C 67711		12/8/1998	APPR

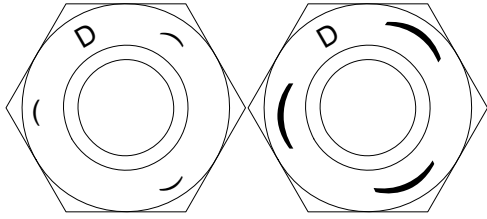

499-01	Decker Mfg. Corp.	Albion	MI		
Nut	A 563 Gr C3 Hvy Series Blk	M/C 65604		12/8/1998	APPR

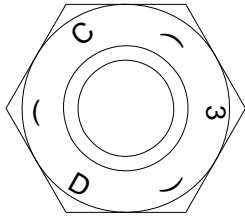

499-01	Decker Mfg. Corp.	Albion	MI		
Nut	A 563 Gr C3 Hvy Series Gv	M/C 67733		12/8/1998	APPR

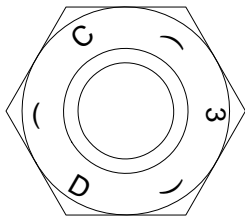

P/S#	P/S Name	City	State	EDate	Status
499-01	Decker Mfg. Corp.	Albion	MI		
Nut	A 563 Gr C3 Hvy Series Lock	M/C 65607		12/8/1998	APPR

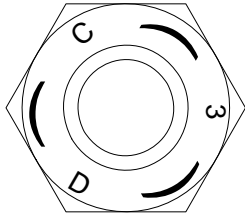

LOCK NUT

499-01	Decker Mfg. Corp.	Albion	MI		
Nut	A 563 Gr DH Hvy Series Blk	M/C 65606		10/3/2008	APPR

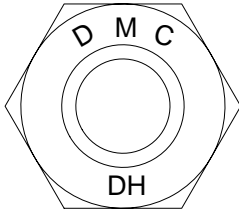

499-01	Decker Mfg. Corp.	Albion	MI		
Nut	A 563 Gr DH Hvy Series Gv	M/C 67717		10/3/2008	APPR

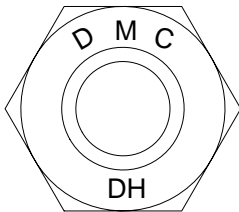

P/S#	P/S Name	City	State	EDate	Status
------	----------	------	-------	-------	--------

4686-01

4686-01 Del-Val Fastener Mfg. Co., Inc Ivyland PA
 Nut A 194 Gr 8 TyB Reg & Hvy Series Blk M/C 67707 12/8/1998 APPR

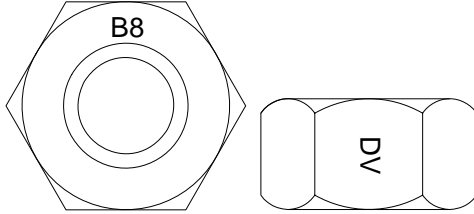

4686-01 Del-Val Fastener Mfg. Co., Inc Ivyland PA
 Nut A 194 Gr 8 TyB Reg & Hvy Series Gv M/C 67707 12/8/1998 APPR

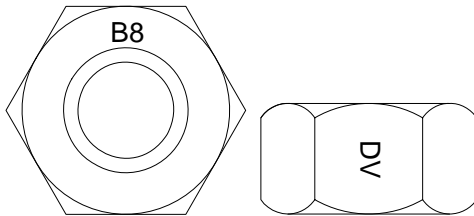

4686-01 Del-Val Fastener Mfg. Co., Inc Ivyland PA
 Nut A 194 Gr 8F TyB Reg & Hvy Series Bl M/C 67708 12/8/1998 APPR

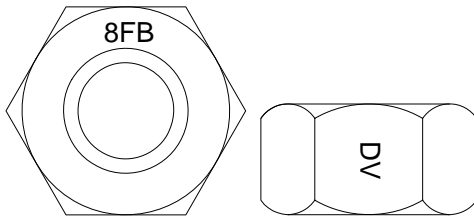

P/S#	P/S Name	City	State	EDate	Status
4686-01	Del-Val Fastener Mfg. Co., Inc	Ivyland	PA		
Nut	A 194 Gr 8F TyB Reg & Hvy Series G	M/C 67708		12/8/1998	APPR

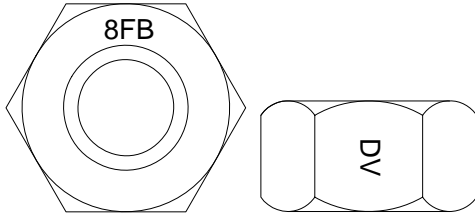

P/S#	P/S Name	City	State	EDate	Status
------	----------	------	-------	-------	--------

4744-01

4744-01 Domestic Forging, Inc, New Haven MI
 Nut A 194 Gr 2 Hvy Series Blk M/C 65601 10/18/2001 APPR

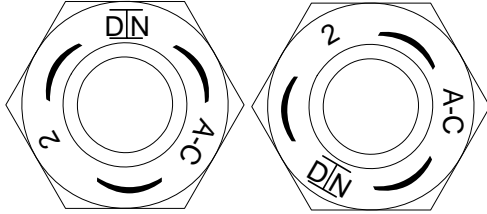

4744-01 Domestic Forging, Inc, New Haven MI
 Nut A 194 Gr 2 Hvy Series Gv M/C 67703 10/18/2001 APPR

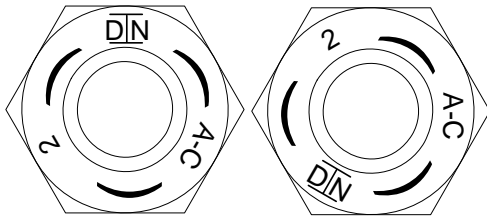

4744-01 Domestic Forging, Inc, New Haven MI
 Nut A 194 Gr 2H Hvy Series Blk M/C 65602 10/18/2001 APPR

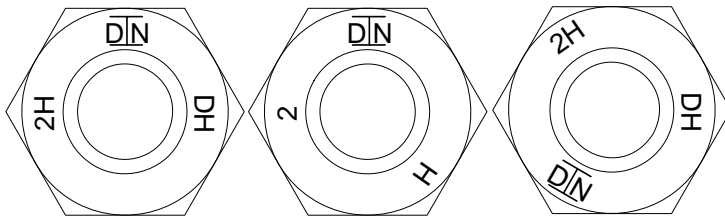

P/S#	P/S Name	City	State	EDate	Status
------	----------	------	-------	-------	--------

4744-01	Domestic Forging, Inc,	New Haven	MI		
Nut	A 194 Gr 2H Hvy Series Gv	M/C 67704		10/18/2001	APPR

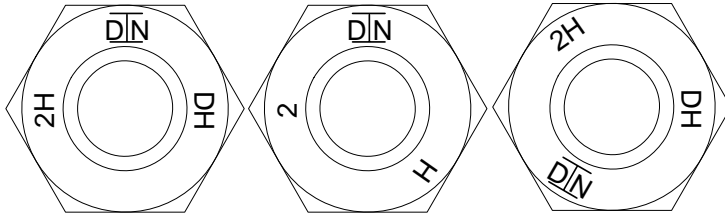

4744-01	Domestic Forging, Inc,	New Haven	MI		
Nut	A 563 Gr A Reg & Hvy Series Blk	M/C 67728		10/18/2001	APPR

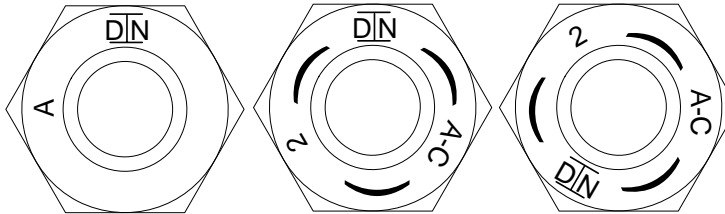

4744-01	Domestic Forging, Inc,	New Haven	MI		
Nut	A 563 Gr A Reg & Hvy Series Gv	M/C 67729		10/18/2001	APPR

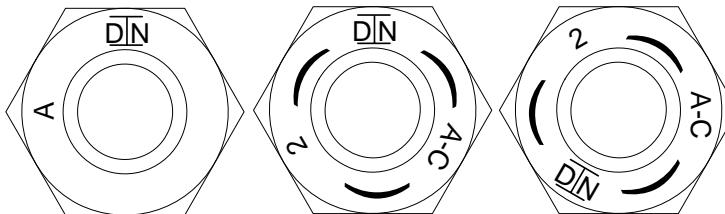

P/S#	P/S Name	City	State	EDate	Status
------	----------	------	-------	-------	--------

4744-01	Domestic Forging, Inc,	New Haven	MI		
Nut	A 563 Gr C Hvy Series Blk	M/C 65603		10/18/2001	APPR

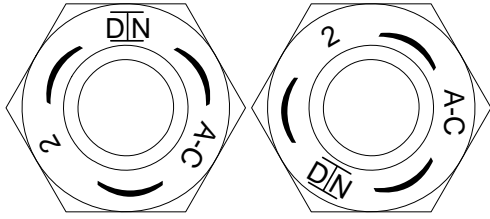

4744-01	Domestic Forging, Inc,	New Haven	MI		
Nut	A 563 Gr C Hvy Series Gv	M/C 67711		10/18/2001	APPR

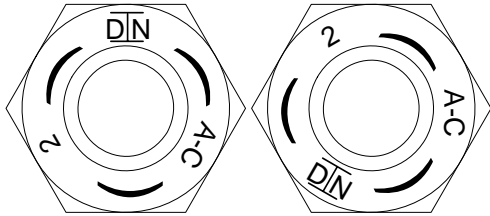

4744-01	Domestic Forging, Inc,	New Haven	MI		
Nut	A 563 Gr DH 3 Hvy Series Blk	M/C 67734		10/18/2001	APPR

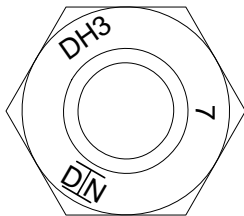

P/S#	P/S Name	City	State	EDate	Status
------	----------	------	-------	-------	--------

4744-01	Domestic Forging, Inc,	New Haven	MI		
Nut	A 563 Gr DH Hvy Series Blk	M/C 65606		10/18/2001	APPR

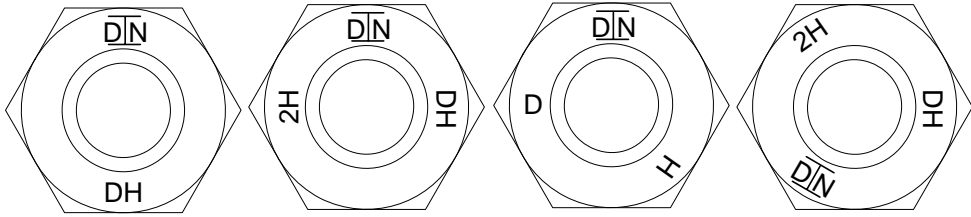

4744-01	Domestic Forging, Inc,	New Haven	MI		
Nut	A 563 Gr DH Hvy Series Gv	M/C 67717		10/18/2001	APPR

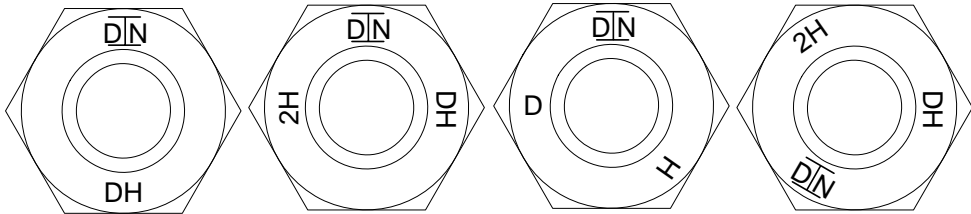

P/S#	P/S Name	City	State	EDate	Status
------	----------	------	-------	-------	--------

5709-01

5709-01 Dyson Corp. Domestic Painesville OH
 Nut A 194 Gr 2 Hvy Series Blk M/C 65601 5/16/2008 APPR

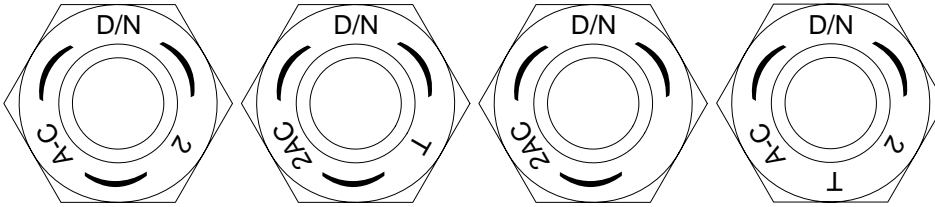

5709-01 Dyson Corp. Domestic Painesville OH
 Nut A 194 Gr 2 Hvy Series Gv M/C 67703 5/16/2008 APPR

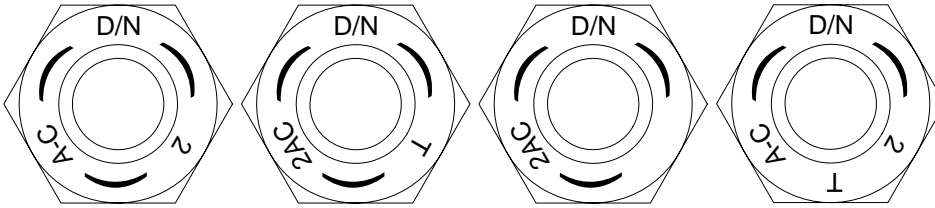

5709-01 Dyson Corp. Domestic Painesville OH
 Nut A 194 Gr 2H Hvy Series Blk M/C 65602 5/16/2008 APPR

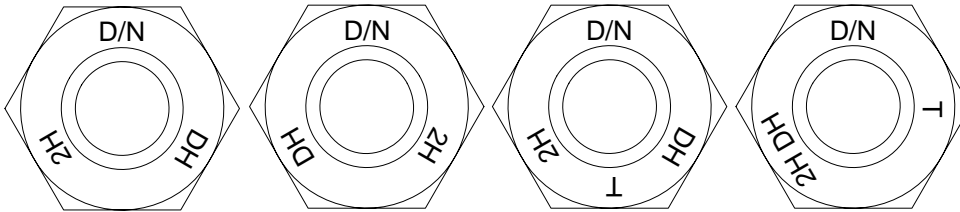

P/S#	P/S Name	City	State	EDate	Status
------	----------	------	-------	-------	--------

5709-01 Dyson Corp. Domestic Painesville OH
 Nut A 194 Gr 2H Hvy Series Gv M/C 67704 5/16/2008 APPR

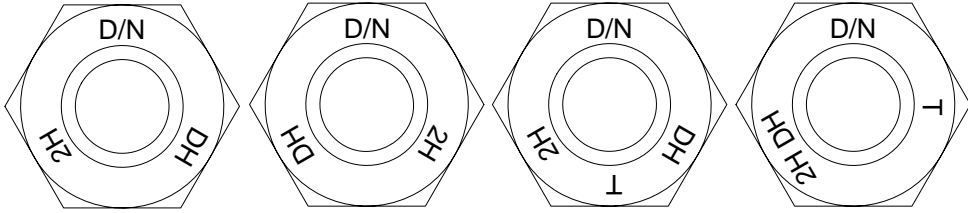

5709-01 Dyson Corp. Domestic Painesville OH
 Nut A 563 Gr A Reg & Hvy Series Blk M/C 67728 5/16/2008 APPR

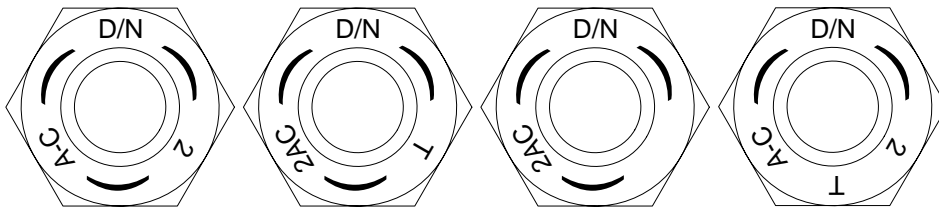

5709-01 Dyson Corp. Domestic Painesville OH
 Nut A 563 Gr A Reg & Hvy Series Gv M/C 67729 5/16/2008 APPR

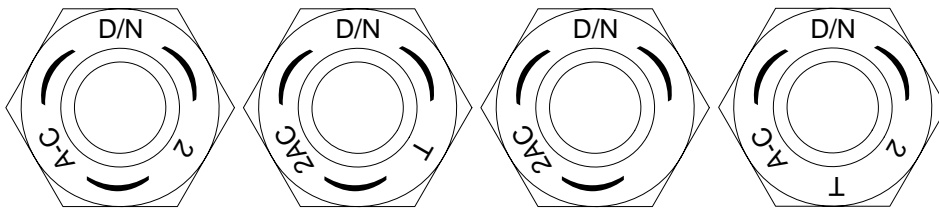

P/S#	P/S Name	City	State	EDate	Status
------	----------	------	-------	-------	--------

5709-01 Dyson Corp. Domestic Painesville OH
 Nut A 563 Gr C Hvy Series Blk M/C 65603 5/16/2008 APPR

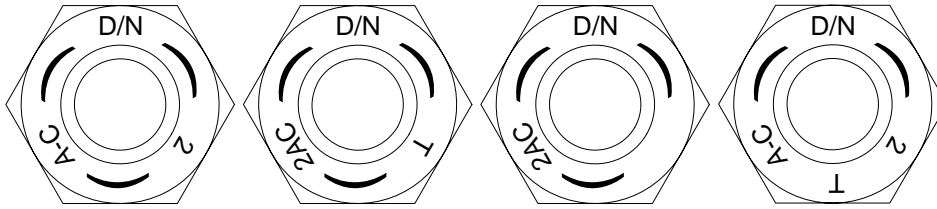

5709-01 Dyson Corp. Domestic Painesville OH
 Nut A 563 Gr C Hvy Series Gv M/C 67711 5/16/2008 APPR

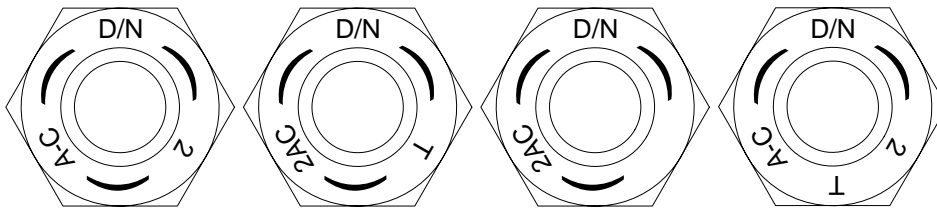

5709-01 Dyson Corp. Domestic Painesville OH
 Nut A 563 Gr DH 3 Hvy Series Blk M/C 67734 10/18/2001 APPR

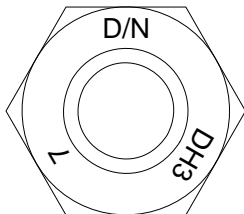

P/S#	P/S Name	City	State	EDate	Status
------	----------	------	-------	-------	--------

5709-01 Dyson Corp. Domestic Painesville OH

Nut A 563 Gr DH Hvy Series Blk M/C 65606 5/16/2008 APPR

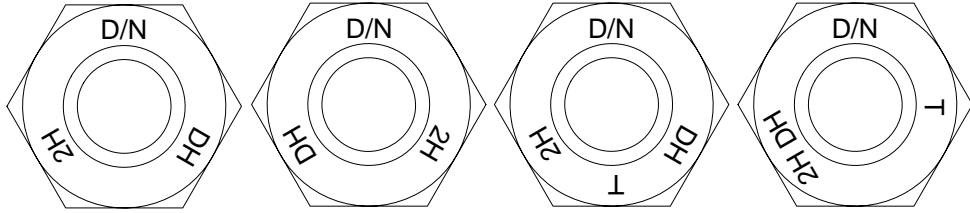

5709-01 Dyson Corp. Domestic Painesville OH

Nut A 563 Gr DH Hvy Series Gv M/C 67717 5/16/2008 APPR

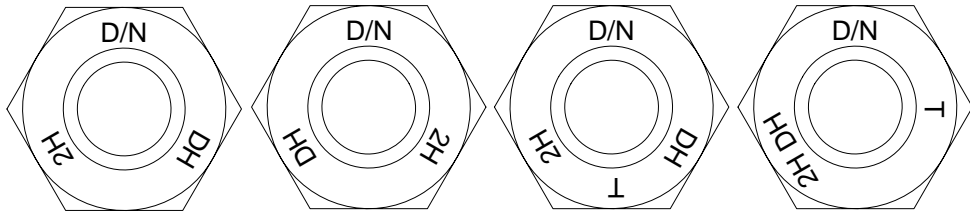

P/S#	P/S Name	City	State	EDate	Status
------	----------	------	-------	-------	--------

2253-01

2253-01	Jacobson Mfg. Co., Inc.	Kenilworth	NJ		
Nut	A 194 Gr 2 Hvy Series Blk	M/C 65601		12/8/1998	APPR

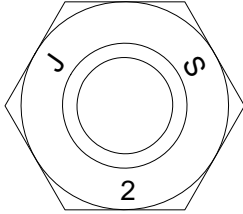

2253-01	Jacobson Mfg. Co., Inc.	Kenilworth	NJ		
Nut	A 194 Gr 2 Hvy Series Gv	M/C 67703		12/8/1998	APPR

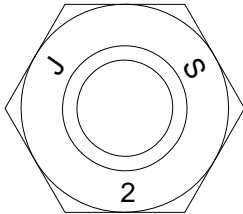

2253-01	Jacobson Mfg. Co., Inc.	Kenilworth	NJ		
Nut	A 194 Gr 2H Hvy Series Blk	M/C 65602		12/8/1998	APPR

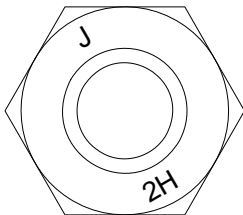

P/S#	P/S Name	City	State	EDate	Status
2253-01	Jacobson Mfg. Co., Inc.	Kenilworth	NJ		
Nut	A 194 Gr 2H Hvy Series Gv	M/C 67704		12/8/1998	APPR

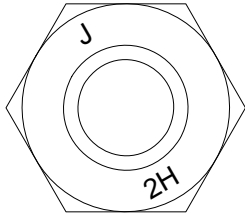

P/S#	P/S Name	City	State	EDate	Status
------	----------	------	-------	-------	--------

551-01

551-01	Joseph Dyson & Sons	Painesville	OH		
Nut	A 194 Gr 2 Hvy Series Blk	M/C 65601		12/8/1998	APPR

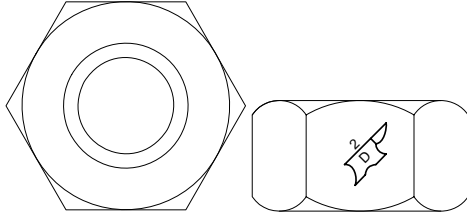

551-01	Joseph Dyson & Sons	Painesville	OH		
Nut	A 194 Gr 2 Hvy Series Gv	M/C 67703		12/8/1998	APPR

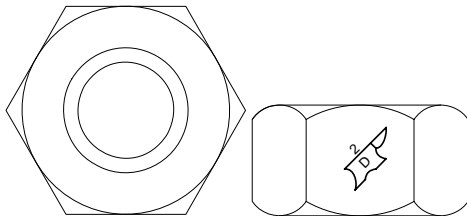

551-01	Joseph Dyson & Sons	Painesville	OH		
Nut	A 194 Gr 2H Hvy Series Blk	M/C 65602		12/8/1998	APPR

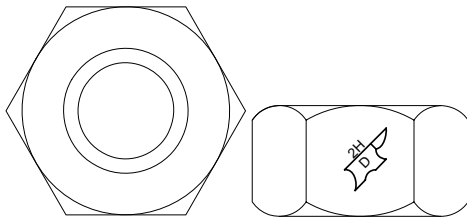

P/S#	P/S Name	City	State	EDate	Status
------	----------	------	-------	-------	--------

551-01	Joseph Dyson & Sons	Painesville	OH		
Nut	A 194 Gr 2H Hvy Series Gv	M/C 67704		12/8/1998	APPR

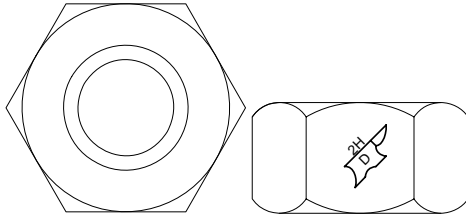

551-01	Joseph Dyson & Sons	Painesville	OH		
Nut	A 563 Gr A Reg & Hvy Series Blk	M/C 67728		12/8/1998	APPR

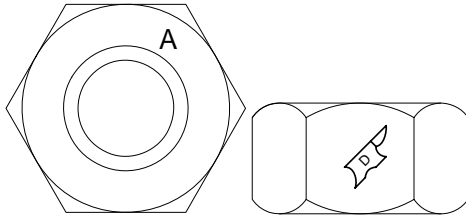

551-01	Joseph Dyson & Sons	Painesville	OH		
Nut	A 563 Gr A Reg & Hvy Series Gv	M/C 67729		12/8/1998	APPR

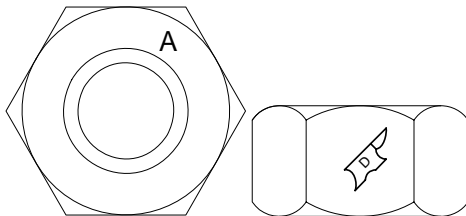

P/S#	P/S Name	City	State	EDate	Status
------	----------	------	-------	-------	--------

4440-01

4440-01	Le Jeune Bolt Co.	Lakeville	MN		
Nut	A 194 Gr 2H Hvy Series Blk	M/C 65602	10/18/2001	APPR	

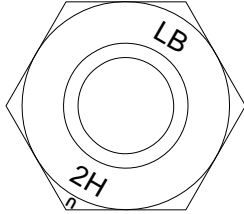

Produced for Lejeune Bolt by P/S# 2010-02

4440-01	Le Jeune Bolt Co.	Lakeville	MN		
Nut	A 194 Gr 2H Hvy Series Gv	M/C 67704	10/18/2001	APPR	

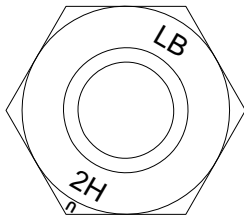

Produced for Lejeune Bolt by P/S# 2010-02

P/S#	P/S Name	City	State	EDate	Status
------	----------	------	-------	-------	--------

2724-02

2724-02	Metform, Inc.	Savanna	IL		
Nut	A 194 Gr 2H Hvy Series Blk	M/C 65602	12/8/1998	APPR	

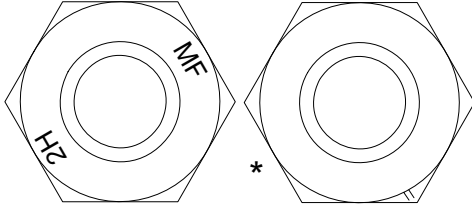

* On Opposite Side of the bolt

2724-02	Metform, Inc.	Savanna	IL		
Nut	A 194 Gr 2H Hvy Series Lock Gv	M/C 67706	12/8/1998	APPR	

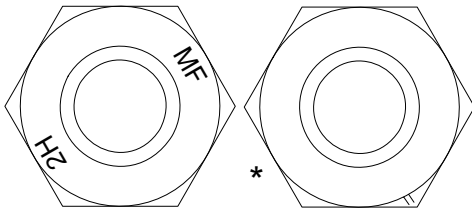

* On Opposite Side of the bolt

2724-02	Metform, Inc.	Savanna	IL		
Nut	A 563 Gr C Hvy Series Blk	M/C 65603	12/8/1998	APPR	

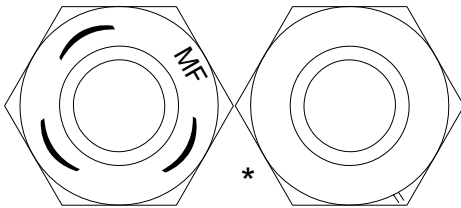

* On Opposite Side of the bolt

P/S#	P/S Name	City	State	EDate	Status
------	----------	------	-------	-------	--------

2724-02	Metform, Inc.	Savanna	IL		
Nut	A 563 Gr C Hvy Series Gv	M/C 67711		12/8/1998	APPR

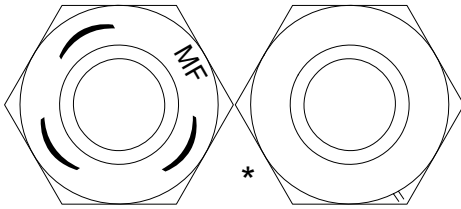

* On Opposite Side of the bolt

2724-02	Metform, Inc.	Savanna	IL		
Nut	A 563 Gr C3 Hvy Series Gv	M/C 67733		12/8/1998	APPR

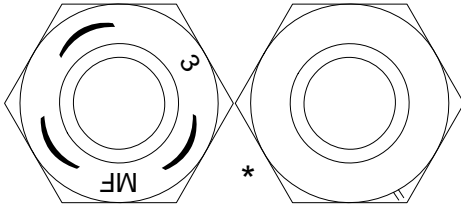

* On Opposite Side of the bolt

2724-02	Metform, Inc.	Savanna	IL		
Nut	A 563 Gr DH Hvy Series Blk	M/C 65606		12/8/1998	APPR

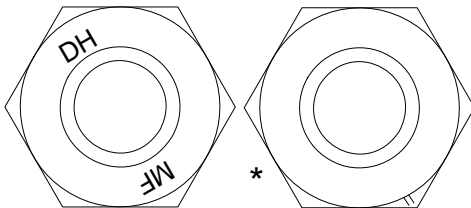

* On Opposite Side of the bolt

P/S#	P/S Name	City	State	EDate	Status
2724-02	Metform, Inc.	Savanna	IL		
Nut	A 563 Gr DH Hvy Series Gv	M/C 67717		12/8/1998	APPR

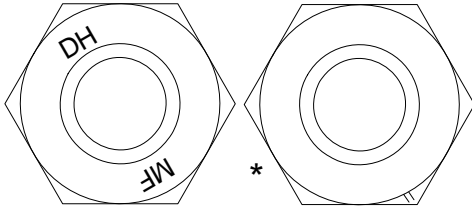

* On Opposite Side of the bolt

P/S#	P/S Name	City	State	EDate	Status
------	----------	------	-------	-------	--------

4392-01

4392-01 NSS Industries Plymouth MI
 Nut A 194 Gr 2H Hvy Series Blk M/C 65602 12/8/1998 APPR

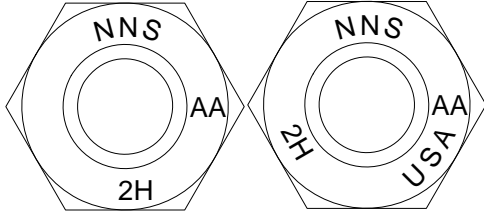

AA is variable

4392-01 NSS Industries Plymouth MI
 Nut A 194 Gr 2H Hvy Series Gv M/C 67704 12/8/1998 APPR

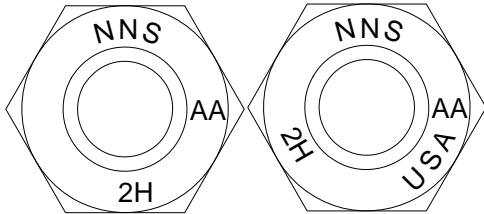

AA is variable

4392-01 NSS Industries Plymouth MI
 Nut A 563 Gr DH Hvy Series Blk M/C 65606 12/8/1998 APPR

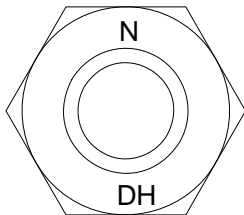

P/S#	P/S Name	City	State	EDate	Status
4392-01	NSS Industries	Plymouth	MI		
Nut	A 563 Gr DH Hvy Series Gv	M/C 67717		12/8/1998	APPR

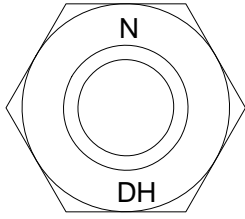

P/S#	P/S Name	City	State	EDate	Status
------	----------	------	-------	-------	--------

2394-05

2394-05	Nucor Fasteners	St. Joe	IN
Nut	A 194 Gr 2H Hvy Series Blk	M/C 65602	12/8/1998 APPR

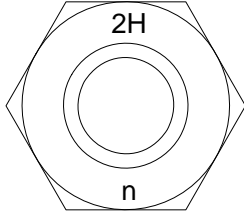

2394-05	Nucor Fasteners	St. Joe	IN
Nut	A 194 Gr 2H Hvy Series Gv	M/C 67704	12/8/1998 APPR

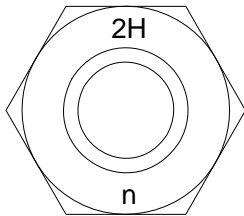

2394-05	Nucor Fasteners	St. Joe	IN
Nut	A 563 Gr A Reg & Hvy Series Blk Rec	M/C 65609	10/18/2001 APPR

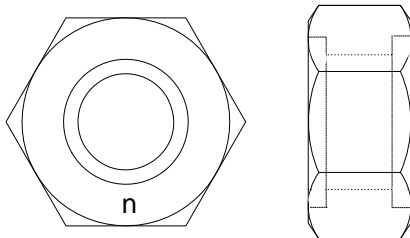

P/S#	P/S Name	City	State	EDate	Status
2394-05	Nucor Fasteners	St. Joe	IN		
Nut	A 563 Gr A Reg & Hvy Series Gv Rece	M/C 65610		10/18/2001	APPR

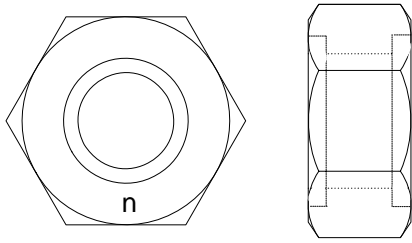

2394-05	Nucor Fasteners	St. Joe	IN		
Nut	A 563 Gr C Hvy Series Blk	M/C 65603		12/8/1998	APPR

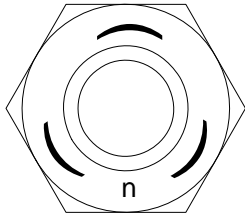

2394-05	Nucor Fasteners	St. Joe	IN		
Nut	A 563 Gr C Hvy Series Gv	M/C 67711		12/8/1998	APPR

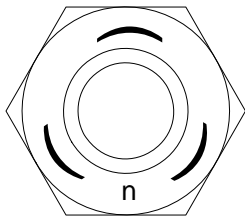

P/S#	P/S Name	City	State	EDate	Status
2394-05	Nucor Fasteners	St. Joe	IN		
Nut	A 563 Gr C3 Hvy Series Blk	M/C 65604		12/8/1998	APPR

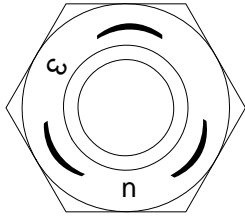

2394-05	Nucor Fasteners	St. Joe	IN		
Nut	A 563 Gr C3 Hvy Series Gv	M/C 67733		12/8/1998	APPR

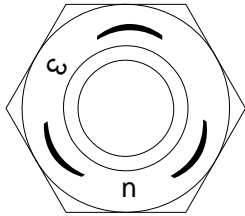

2394-05	Nucor Fasteners	St. Joe	IN		
Nut	A 563 Gr DH Hvy Series Blk	M/C 65606		12/8/1998	APPR

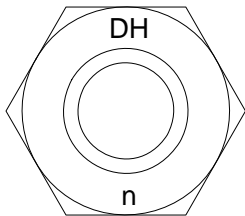

P/S#	P/S Name	City	State	EDate	Status
2394-05	Nucor Fasteners	St. Joe	IN		
Nut	A 563 Gr DH Hvy Series Gv	M/C 67717		12/8/1998	APPR

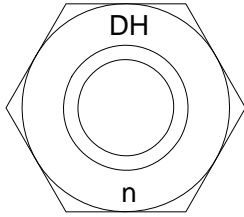

2394-05	Nucor Fasteners	St. Joe	IN		
Nut	A 563 Gr DH3 Hvy Series Blk	M/C 67734		12/8/1998	APPR

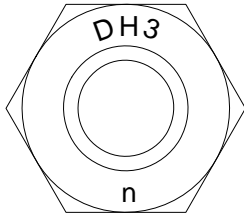

P/S#	P/S Name	City	State	EDate	Status
------	----------	------	-------	-------	--------

1715-02

1715-02 R B & W Corp. Caraopolis PA
 Nut A 563 Gr A Reg & Hvy Series Blk M/C 67728 12/8/1998 APPR

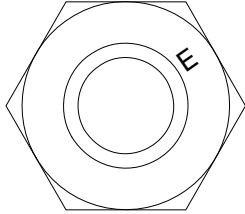

1715-02 R B & W Corp. Caraopolis PA
 Nut A 563 Gr A Reg & Hvy Series Gv M/C 67729 12/8/1998 APPR

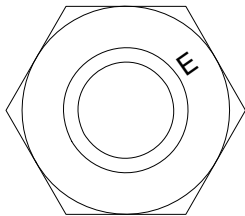

1715-02 R B & W Corp. Caraopolis PA
 Nut A 563 Gr C Hvy Series Blk M/C 65603 12/8/1998 APPR

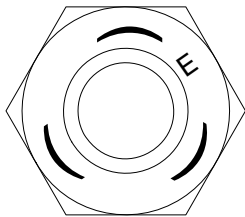

P/S#	P/S Name	City	State	EDate	Status
1715-02	R B & W Corp.	Caraopolis	PA		
Nut	A 563 Gr C Hvy Series Gv	M/C 67711		12/8/1998	APPR

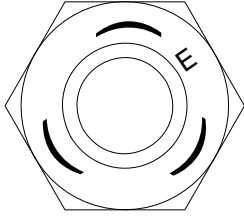

P/S#	P/S Name	City	State	EDate	Status
------	----------	------	-------	-------	--------

4438-01

4438-01	Robbins Mfg. Co., Inc.	Fall River	MA
Nut	A 194 Gr 8 Stainless Steel	M/C 67731	4/10/2000 APPR

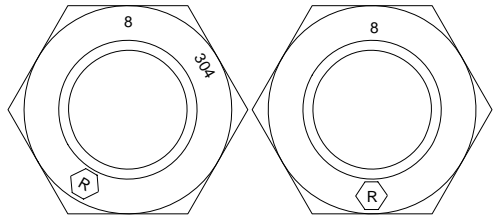

P/S#	P/S Name	City	State	EDate	Status
------	----------	------	-------	-------	--------

4027-01

4027-01	Sheffield, Inc.	Kansas	MO
Nut	A 563 Gr C Hvy Series Blk	M/C 65603	12/8/1998 APPR

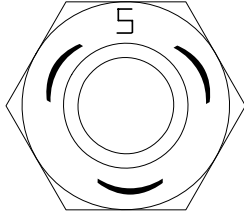

4027-01	Sheffield, Inc.	Kansas	MO
Nut	A 563 Gr C Hvy Series Gv	M/C 67711	12/8/1998 APPR

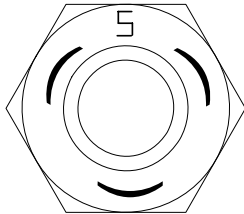

4027-01	Sheffield, Inc.	Kansas	MO
Nut	A 563 Gr C3 Hvy Series Blk	M/C 65604	12/8/1998 APPR

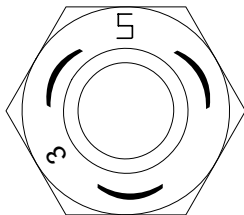

P/S#	P/S Name	City	State	EDate	Status
4027-01	Sheffield, Inc.	Kansas	MO		
Nut	A 563 Gr C3 Hvy Series Gv	M/C 67733		12/8/1998	APPR

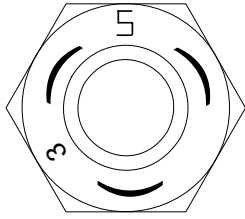

P/S#	P/S Name	City	State	EDate	Status
------	----------	------	-------	-------	--------

2984-01

2984-01	Standard Bolt & Nut Co.	Cumberland	RI		
Nut	A 194 Gr 8 Hvy Series Blk	M/C 67707		12/8/1998	APPR

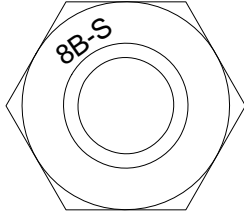

2984-01	Standard Bolt & Nut Co.	Cumberland	RI		
Nut	A 194 Gr 8 Hvy Series Gv	M/C 67707		12/8/1998	APPR

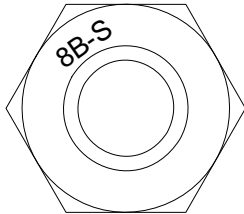

P/S#	P/S Name	City	State	EDate	Status
------	----------	------	-------	-------	--------

4493-01

4493-01	Telefast Industries, Inc.	Berea	OH		
Nut	A 194 Gr 2H Hvy Series Blk	M/C 65602		12/8/1998	APPR

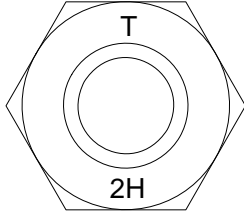

4493-01	Telefast Industries, Inc.	Berea	OH		
Nut	A 194 Gr 2H Hvy Series Gv	M/C 67704		12/8/1998	APPR

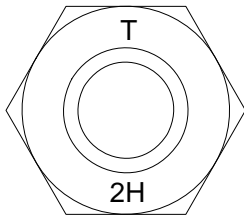

4493-01	Telefast Industries, Inc.	Berea	OH		
Nut	A 563 Gr A Reg & Hvy Series Blk	M/C 67728		12/28/1998	APPR

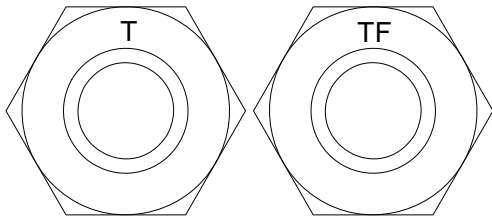

P/S#	P/S Name	City	State	EDate	Status
------	----------	------	-------	-------	--------

4493-01	Telefast Industries, Inc.	Berea	OH		
Nut	A 563 Gr A Reg & Hvy Series Gv	M/C 67729		12/8/1998	APPR

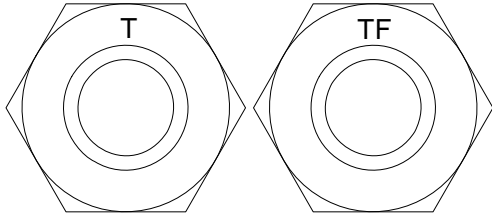

4493-01	Telefast Industries, Inc.	Berea	OH		
Nut	A 563 Gr C Hvy Series Blk	M/C 65603		12/8/1998	APPR

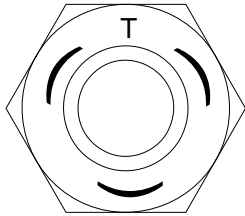

4493-01	Telefast Industries, Inc.	Berea	OH		
Nut	A 563 Gr C Hvy Series Gv	M/C 67711		12/8/1998	APPR

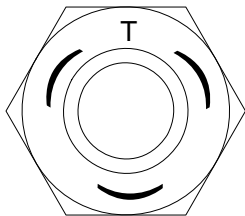

P/S#	P/S Name	City	State	EDate	Status
------	----------	------	-------	-------	--------

4493-01	Telefast Industries, Inc.	Berea	OH		
Nut	A 563 Gr C3 Hvy Series Blk	M/C 65604		12/8/1998	APPR

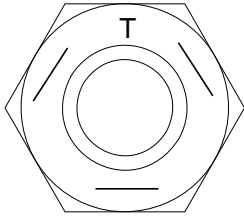

4493-01	Telefast Industries, Inc.	Berea	OH		
Nut	A 563 Gr C3 Hvy Series Gv	M/C 67733		12/8/1998	APPR

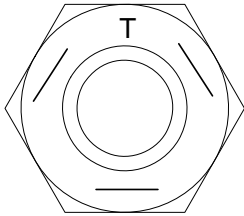

4493-01	Telefast Industries, Inc.	Berea	OH		
Nut	A 563 Gr DH Hvy Series Blk	M/C 65606		12/8/1998	APPR

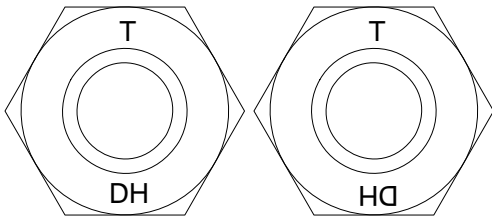

P/S#	P/S Name	City	State	EDate	Status
4493-01	Telefast Industries, Inc.	Berea	OH		
Nut	A 563 Gr DH Hvy Series Gv	M/C 67717		12/8/1998	APPR

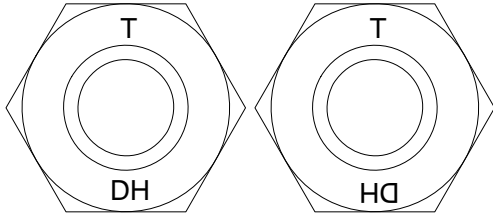

P/S#	P/S Name	City	State	EDate	Status
------	----------	------	-------	-------	--------

1911-01

1911-01	Texas Bolt Company	Houston	TX
Nut	A 194 Gr 2 Hvy Series Blk	M/C 65601	12/8/1998 APPR

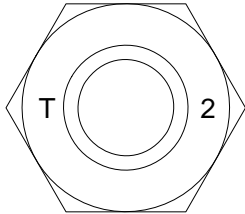

1911-01	Texas Bolt Company	Houston	TX
Nut	A 194 Gr 2 Hvy Series Gv	M/C 67703	12/8/1998 APPR

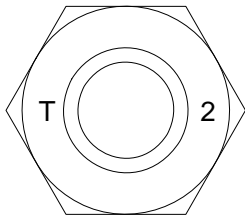

1911-01	Texas Bolt Company	Houston	TX
Nut	A 194 Gr 2H Hvy Series Blk	M/C 65602	12/8/1998 APPR

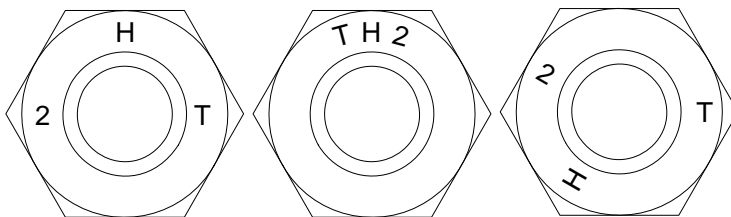

P/S#	P/S Name	City	State	EDate	Status
------	----------	------	-------	-------	--------

1911-01	Texas Bolt Company	Houston	TX		
Nut	A 194 Gr 2H Hvy Series Gv	M/C 67704		12/8/1998	APPR

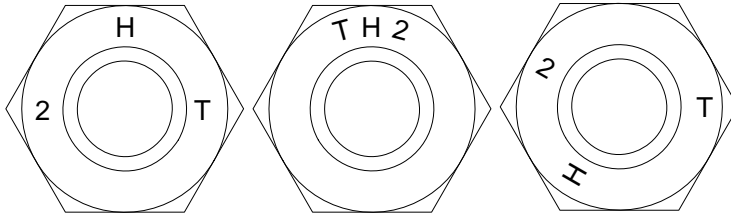

1911-01	Texas Bolt Company	Houston	TX		
Nut	A 194 Gr 2H Hvy Series Lock Blk	M/C 67702		12/8/1998	APPR

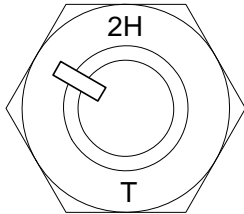

1911-01	Texas Bolt Company	Houston	TX		
Nut	A 194 Gr 2H Hvy Series Lock Gv	M/C 67706		12/8/1998	APPR

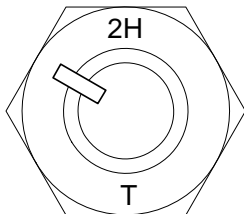

P/S#	P/S Name	City	State	EDate	Status
1911-01	Texas Bolt Company	Houston	TX		
Nut	A 194 Gr 8 Reg & Hvy Series Blk	M/C 67707		12/8/1998	APPR

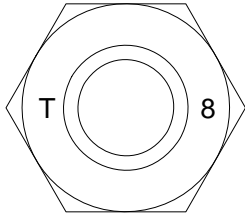

1911-01	Texas Bolt Company	Houston	TX		
Nut	A 194 Gr 8 Reg & Hvy Series Gv	M/C 67707		12/8/1998	APPR

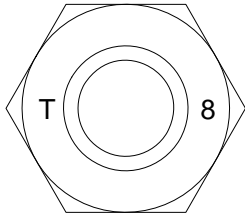

1911-01	Texas Bolt Company	Houston	TX		
Nut	A 194 Gr 8 Stainless Steel	M/C 67731		12/8/1998	APPR

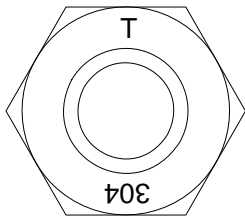

P/S#	P/S Name	City	State	EDate	Status
1911-01	Texas Bolt Company	Houston	TX		
Nut	A 563 Gr A Reg & Hvy Series Blk	M/C 67728		12/8/1998	APPR

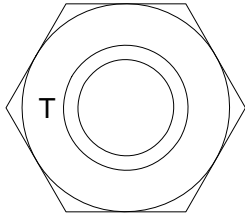

1911-01	Texas Bolt Company	Houston	TX		
Nut	A 563 Gr A Reg & Hvy Series Gv	M/C 67729		12/8/1998	APPR

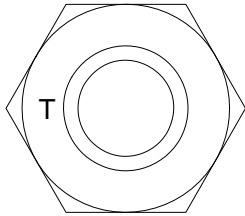

1911-01	Texas Bolt Company	Houston	TX		
Nut	A 563 Gr DH Hvy Series Blk	M/C 65606		10/5/1999	APPR

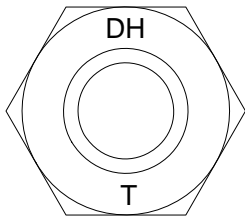

P/S#	P/S Name	City	State	EDate	Status
1911-01	Texas Bolt Company	Houston	TX		
Nut	A 563 Gr DH Hvy Series Gv	M/C 67717		10/5/1999	APPR

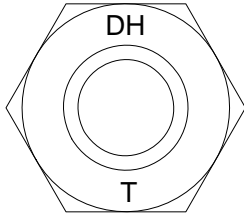

P/S#	P/S Name	City	State	EDate	Status
------	----------	------	-------	-------	--------

2214-03

2214-03	Trinity Industries, Inc.	Lima,	OH
Nut	A 563 Gr A Reg & Hvy Series Blk	M/C 65609	10/18/2001 APPR

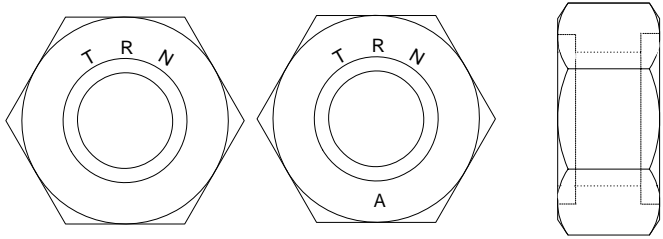

Nut may have letters "A through F" for in house tracking

2214-03	Trinity Industries, Inc.	Lima,	OH
Nut	A 563 Gr A Reg & Hvy Series GvRece	M/C 65610	10/18/2001 APPR

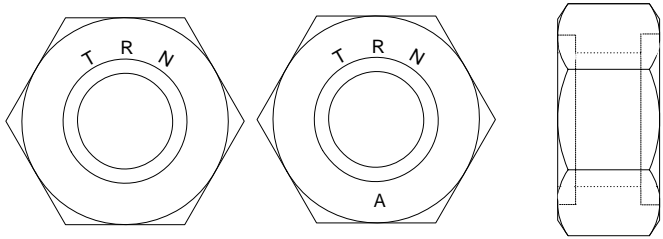

Nut may have letters "A through F" for in house tracking

P/S#	P/S Name	City	State	EDate	Status
------	----------	------	-------	-------	--------

4280-01

4280-01	Tru-Vel Industries	Wellsville	OH		
Nut	A 563 Gr C Hvy Series Blk	M/C 65603		12/8/1998	APPR

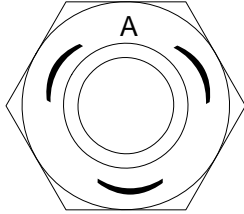

4280-01	Tru-Vel Industries	Wellsville	OH		
Nut	A 563 Gr C Hvy Series Gv	M/C 67711		12/8/1998	APPR

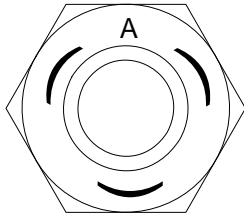

4280-01	Tru-Vel Industries	Wellsville	OH		
Nut	A 563 Gr C3 Hvy Series Blk	M/C 65604		12/8/1998	APPR

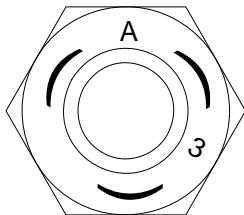

P/S#	P/S Name	City	State	EDate	Status
4280-01	Tru-Vel Industries	Wellsville	OH		
Nut	A 563 Gr C3 Hvy Series Gv	M/C 67733		12/8/1998	APPR

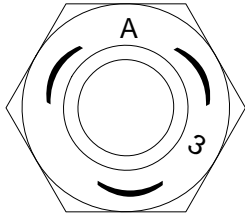

4280-01	Tru-Vel Industries	Wellsville	OH		
Nut	A 563 Gr DH Hvy Series Blk	M/C 65606		12/8/1998	APPR

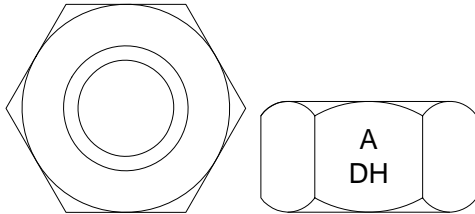

4280-01	Tru-Vel Industries	Wellsville	OH		
Nut	A 563 Gr DH Hvy Series Gv	M/C 67717		12/8/1998	APPR

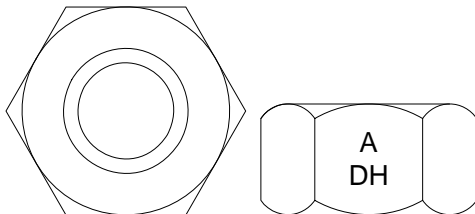

P/S#	P/S Name	City	State	EDate	Status
4280-01	Tru-Vel Industries	Wellsville	OH		
Nut	A 563 Gr DH3 Hvy Series Blk	M/C 67734		12/8/1998	APPR

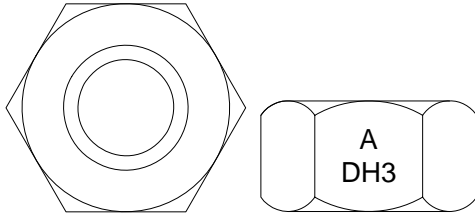

P/S#	P/S Name	City	State	EDate	Status
------	----------	------	-------	-------	--------

2010-02

2010-02 Unytite, Inc. Peru IL
 Nut A 194 Gr 2H Hvy Series Blk M/C 65602 6/6/2000 APPR

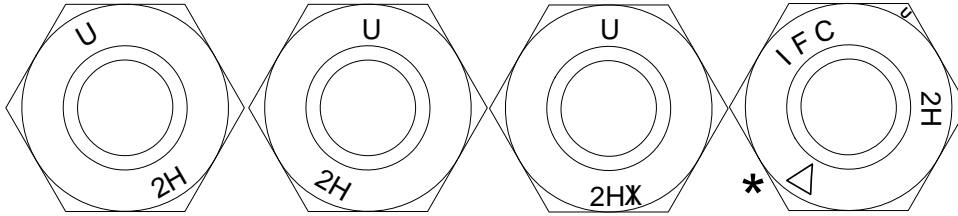

* Is Produced for Vermont Fasteners P/S# 5634-01

2010-02 Unytite, Inc. Peru IL
 Nut A 194 Gr 2H Hvy Series Gv M/C 67704 6/6/2000 APPR

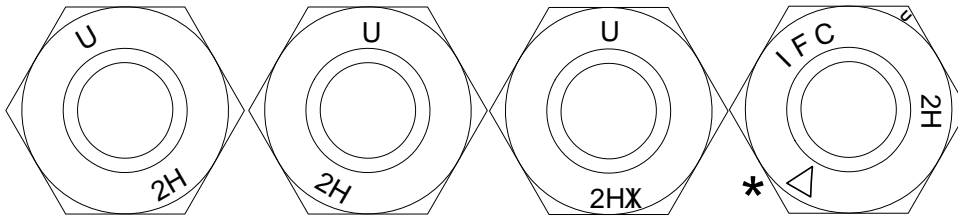

* Is Produced for Vermont Fasteners P/S# 5634-01

2010-02 Unytite, Inc. Peru IL
 Nut A 563 Gr A Reg & Hvy Series Blk M/C 67728 12/8/1998 APPR

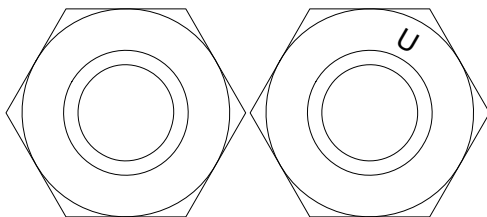

No identification mark required

P/S#	P/S Name	City	State	EDate	Status
2010-02	Unytite, Inc.	Peru	IL		
Nut	A 563 Gr A Reg & Hvy Series Gv	M/C 67729		12/8/1998	APPR

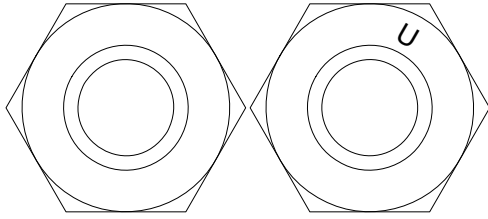

No identification mark required

2010-02	Unytite, Inc.	Peru	IL		
Nut	A 563 Gr C Hvy Series Blk	M/C 65603		6/6/2000	APPR

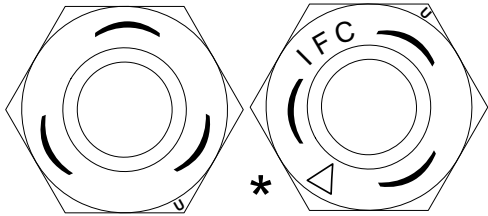

* Is Produced for Vermont Fasteners P/S# 5634-01

2010-02	Unytite, Inc.	Peru	IL		
Nut	A 563 Gr C Hvy Series Gv	M/C 67711		6/6/2000	APPR

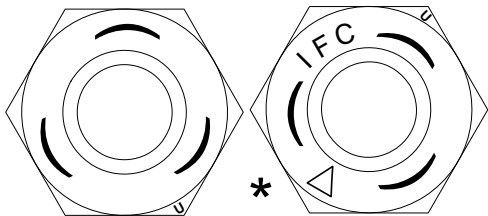

* Is Produced for Vermont Fasteners P/S# 5634-01

P/S#	P/S Name	City	State	EDate	Status
------	----------	------	-------	-------	--------

2010-02	Unytite, Inc.	Peru	IL		
Nut	A 563 Gr C3 Hvy Series Blk	M/C 65604		6/6/2000	APPR

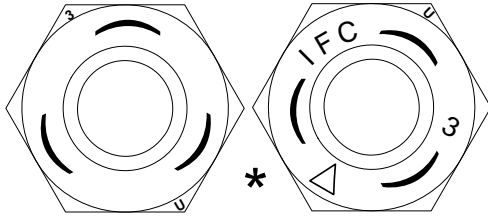

* Is Produced for Vermont Fasteners P/S# 5634-01

2010-02	Unytite, Inc.	Peru	IL		
Nut	A 563 Gr C3 Hvy Series Gv	M/C 67733		6/6/2000	APPR

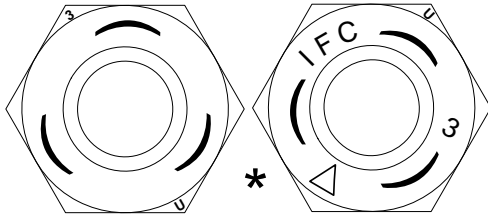

* Is Produced for Vermont Fasteners P/S# 5634-01

2010-02	Unytite, Inc.	Peru	IL		
Nut	A 563 Gr D Hvy Series Blk	M/C 65605		12/8/1998	APPR

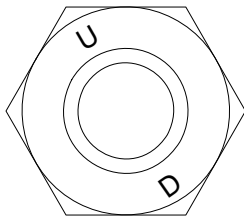

P/S#	P/S Name	City	State	EDate	Status
2010-02	Unytite, Inc.	Peru	IL		
Nut	A 563 Gr D Hvy Series Gv	M/C 67716		12/8/1998	APPR

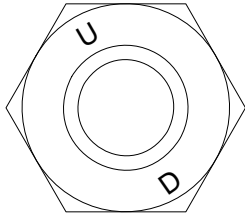

2010-02	Unytite, Inc.	Peru	IL		
Nut	A 563 Gr DH Hvy Series Blk	M/C 65606		10/18/2001	APPR

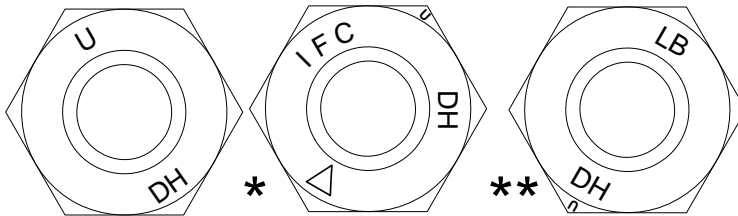

* Produced for Vermont Fasteners P/S# 5634-01, ** Produced for Lejeune Bolt P/S# 4440-01

2010-02	Unytite, Inc.	Peru	IL		
Nut	A 563 Gr DH Hvy Series Gv	M/C 67717		10/18/2001	APPR

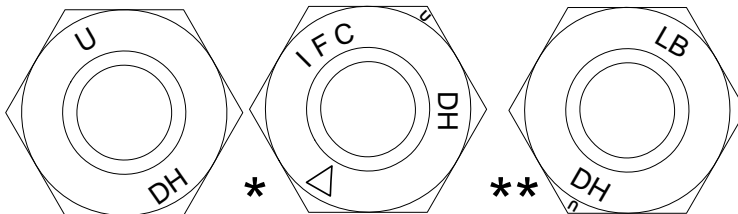

* Produced for Vermont Fasteners P/S# 5634-01, ** Produced for Lejeune Bolt P/S# 4440-01

P/S#	P/S Name	City	State	EDate	Status
2010-02	Unytite, Inc.	Peru	IL		
Nut	A 563 Gr DH Hvy Series Lock Blk	M/C 67719		10/11/2000	APPR

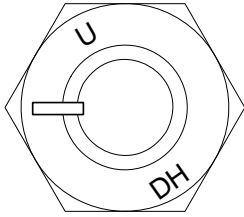

2010-02	Unytite, Inc.	Peru	IL		
Nut	A 563 Gr DH Hvy Series Lock Gv	M/C 67721		10/11/2000	APPR

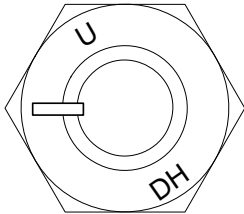

2010-02	Unytite, Inc.	Peru	IL		
Nut	A 563 Gr DH3 Hvy Series Lock	M/C 67735		10/11/2000	APPR

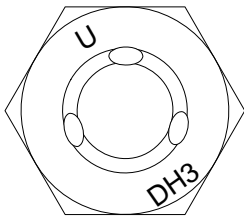

Locking dimples in the outer most thread

P/S#	P/S Name	City	State	EDate	Status
2010-02	Unytite, Inc.	Peru	IL		
Nut	A 563 Gr DH3 Hvy Series Blk	M/C 67734		6/6/2000	APPR

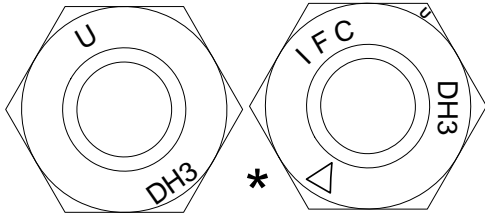

* Is Produced for Vermont Fasteners P/S# 5634-01

P/S#	P/S Name	City	State	EDate	Status
------	----------	------	-------	-------	--------

5634-01

5634-01	Vermont Fastener Manufacturing	Swanton	VT		
Nut	A 194 Gr 2H Hvy Series Blk	M/C 65602		6/6/2000	APPR

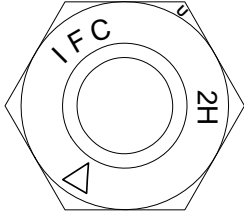

Produced by Unytite P/S# 2010-02. "IFC" needed for domestic origin.

5634-01	Vermont Fastener Manufacturing	Swanton	VT		
Nut	A 194 Gr 2H Hvy Series Gv	M/C 67704		6/6/2000	APPR

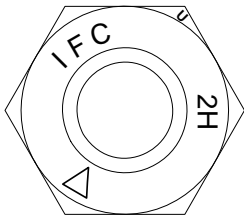

Produced by Unytite P/S# 2010-02. "IFC" needed for domestic origin.

5634-01	Vermont Fastener Manufacturing	Swanton	VT		
Nut	A 563 Gr C Hvy Series Blk	M/C 65603		6/6/2000	APPR



Produced by Unytite P/S# 2010-02. "IFC" needed for domestic origin.

P/S#	P/S Name	City	State	EDate	Status
5634-01	Vermont Fastener Manufacturing	Swanton	VT		
Nut	A 563 Gr C Hvy Series Gv	M/C 67711		6/6/2000	APPR

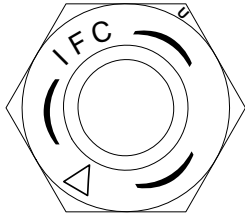

Produced by Unytite P/S# 2010-02. "IFC" needed for domestic orgin.

5634-01	Vermont Fastener Manufacturing	Swanton	VT		
Nut	A 563 Gr C3 Hvy Series Blk	M/C 65604		6/6/2000	APPR

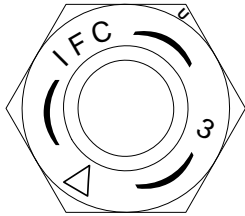

Produced by Unytite P/S# 2010-02. "IFC" needed for domestic orgin.

5634-01	Vermont Fastener Manufacturing	Swanton	VT		
Nut	A 563 Gr C3 Hvy Series Gv	M/C 67733		6/6/2000	APPR

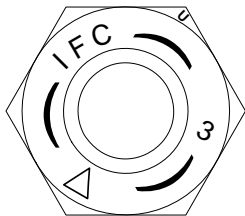

Produced by Unytite P/S# 2010-02. "IFC" needed for domestic orgin.

P/S#	P/S Name	City	State	EDate	Status
5634-01	Vermont Fastener Manufacturing	Swanton	VT		
Nut	A 563 Gr DH 3 Hvy Series Blk	M/C 67734		6/6/2000	APPR

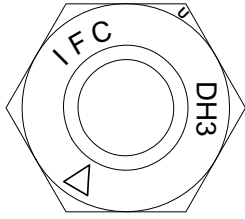

Produced by Unytite P/S# 2010-02. "IFC" needed for domestic orgin.

5634-01	Vermont Fastener Manufacturing	Swanton	VT		
Nut	A 563 Gr DH Hvy Series Blk	M/C 65606		6/6/2000	APPR

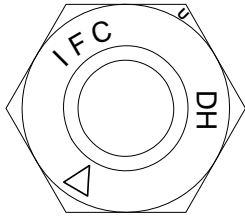

Produced by Unytite P/S# 2010-02. "IFC" needed for domestic orgin.

5634-01	Vermont Fastener Manufacturing	Swanton	VT		
Nut	A 563 Gr DH Hvy Series Gv	M/C 67717		6/6/2000	APPR

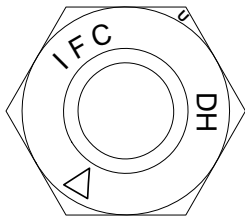

Produced by Unytite P/S# 2010-02. "IFC" needed for domestic orgin.

P/S#	P/S Name	City	State	EDate	Status
------	----------	------	-------	-------	--------

2049-01

2049-01 Vulcan Rivet & Bolt Corp. Birmingham AL
 Nut A 194 Gr 2H Hvy Series Blk M/C 65602 12/8/1998 APPR

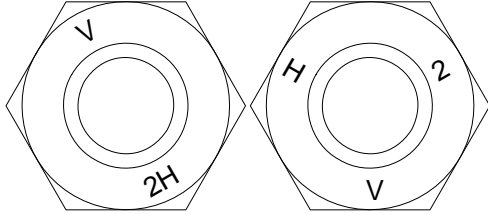

2049-01 Vulcan Rivet & Bolt Corp. Birmingham AL
 Nut A 194 Gr 2H Hvy Series Gv M/C 67704 12/8/1998 APPR

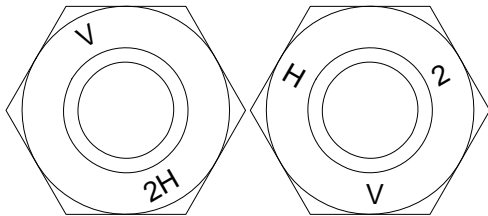

2049-01 Vulcan Rivet & Bolt Corp. Birmingham AL
 Nut A 563 Gr A Reg & Hvy Series Blk M/C 67728 12/8/1998 APPR

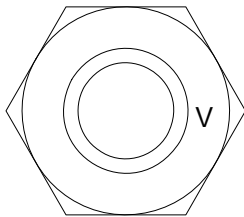

P/S#	P/S Name	City	State	EDate	Status
2049-01	Vulcan Rivet & Bolt Corp.	Birmingham	AL		
Nut	A 563 Gr A Reg & Hvy Series Gv	M/C 67729		12/8/1998	APPR

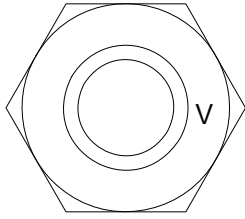

INSTRUCTIONS FOR IDENTIFICATION OF WASHERS

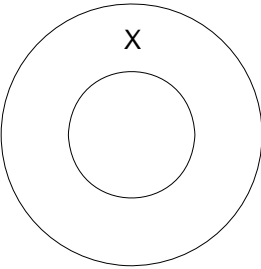
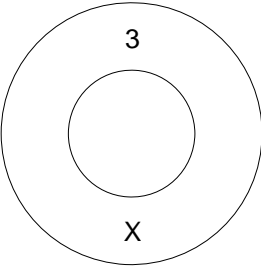
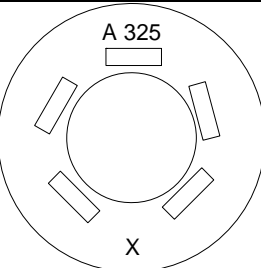
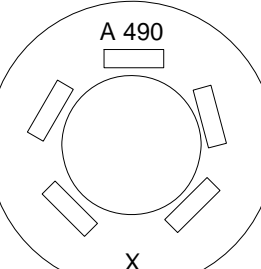
SPECIFICATION AND MATERIAL CODES	GRADE MARKING	REQUIRED MARKINGS
ASTM F 436 65701 Galv 67801		Manufacturer's identification mark, e.g., "X". Other distinguishing marks at option of manufacturer. Markings depressed on one face.
ASTM F 436 Grade 3 65702 Galv. 67818		Manufacturer's identification mark, e.g., "X". Symbol for identification of type, i.e., "3". Other distinguishing marks at option of manufacturer. Markings depressed on one face
ASTM F 959 Type 325 67819 Galv. 67820		Manufacturer's identification mark, e.g., "X". Symbol for identification of type, i.e., "A 325". Markings depressed on the same face as the protrusions.
ASTM F 959 Type 490 67821 Galv. 67822		Manufacturer's identification mark, e.g., "X". Symbol for identification of type, i.e., "A 490". Markings depressed on the same face as the protrusions.

Typical:

Aluminum--77801
 O.G.--67810
 O.G. Galv.--67811
 Square Galv.--67815
 Beveled--67808
 Beveled Galv.--67809
 Beveled Stainless Steel--67816

Flat Carbon Steel--67802
 Flat Galv. Carbon Steel--67804
 Flat Cad. Plated Carbon Steel--67813
 Flat Stainless Steel--67806
 Lock Carbon Steel--67803
 Lock Galv. Carbon Steel--67805
 Lock Cad. Plated. Carbon Steel--67814
 Lock Stainless Steel--67807

Fasteners - Washers

01-Oct-08

P/S#	Paname	City	State	EDate	Status
------	--------	------	-------	-------	--------

5164-01

5164-01	Alpha Stamping Co.	Livonia	MI		
Washer	F 436 CS Blk	M/C 65701		12/8/1998	APPR

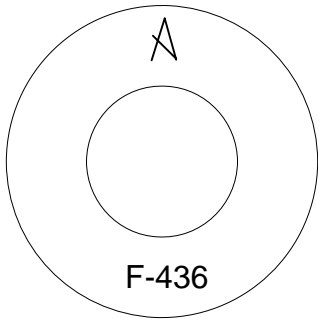

5164-01	Alpha Stamping Co.	Livonia	MI		
Washer	F 436 CS Gv	M/C 67801		12/8/1998	APPR

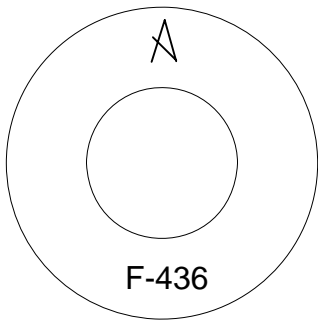

5164-01	Alpha Stamping Co.	Livonia	MI		
Washer	F 436 Ty 3 WS Blk	M/C 65702		12/8/1998	APPR

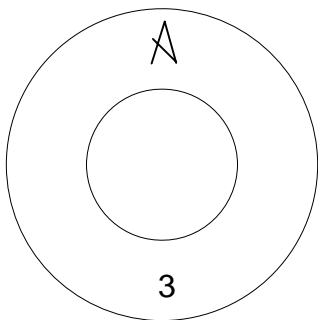

P/S#	Psname	City	State	EDate	Status
5164-01	Alpha Stamping Co.	Livonia	MI		
Washer	F 436 Ty 3 WS Gv	M/C 67818		12/8/1998	APPR

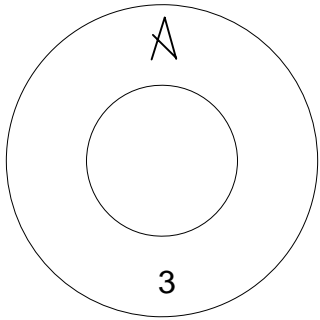

P/S#	Psname	City	State	EDate	Status
------	--------	------	-------	-------	--------

5753-01

5753-01 Andre' Corporation Elkhart IN
 Washer F 436 CS Blk M/C 65701 5/16/2008 APPR

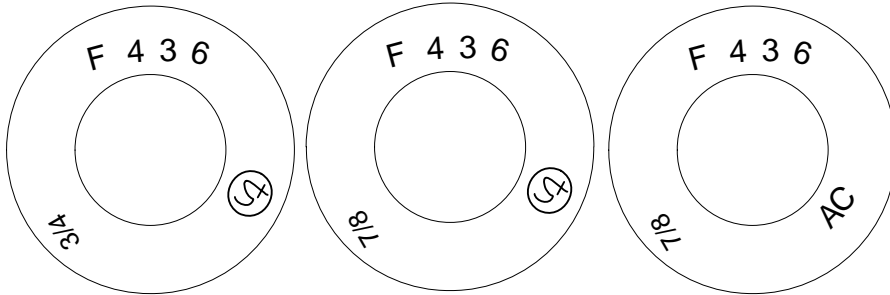

5753-01 Andre' Corporation Elkhart IN
 Washer F 436 CS Gv M/C 67801 5/16/2008 APPR

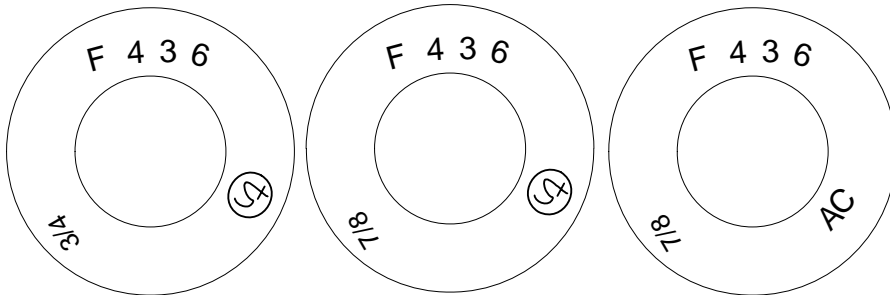

P/S#	Paname	City	State	EDate	Status
------	--------	------	-------	-------	--------

5360-01

5360-01	Applied Bolting Technology	Ludlow	VT		
Washer	F 959 DTI A 325/490 Blk/	M/C 67819/6782		10/18/2001	APPR

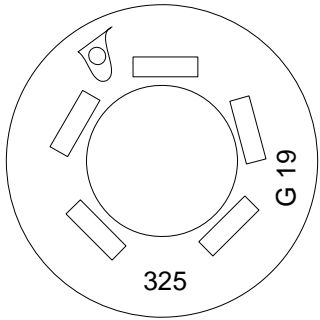

5360-01	Applied Bolting Technology	Ludlow	VT		
Washer	F 959 DTI A 490 Blk	M/C 67821		10/18/2001	APPR

In the case of ASTM A-490, 490 will replace the 325.

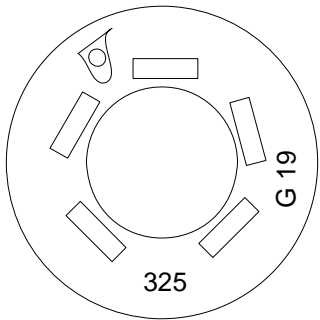

P/S#	Paname	City	State	EDate	Status
------	--------	------	-------	-------	--------

4252-01

4252-01 Applied Press Technologies Elwood City PA
 Washer F 436 CS Blk M/C 65701 12/8/1998 APPR

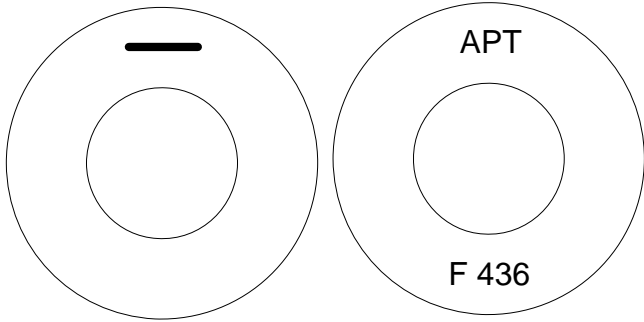

4252-01 Applied Press Technologies Elwood City PA
 Washer F 436 CS Gv M/C 67801 12/8/1998 APPR

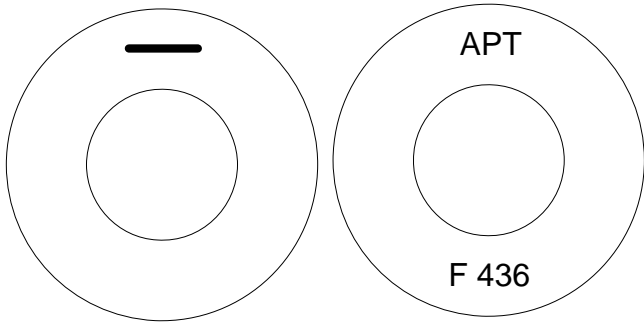

P/S#	Paname	City	State	EDate	Status
------	--------	------	-------	-------	--------

4351-01

4351-01	Beth-Fast Mfg.	Plymouth	MN		
Washer	F 959 DTI A 325/490 Blk/	M/C 67819/6782		12/8/1998	APPR

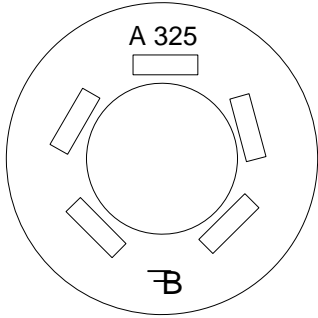

4351-01	Beth-Fast Mfg.	Plymouth	MN		
Washer	F 959 DTI A 490 Blk	M/C 67821		12/8/1998	APPR

In the case of ASTM A-490, 490 will replace the 325.

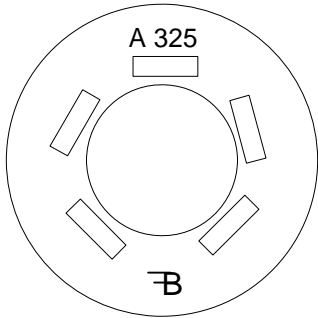

P/S#	Psname	City	State	EDate	Status
------	--------	------	-------	-------	--------

216-01

216-01	Binder Metal Products	Gardena	CA		
Washer	F 436 CS Blk	M/C 65701		12/8/1998	APPR

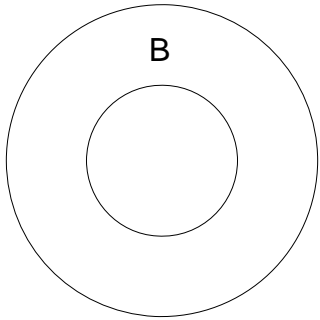

216-01	Binder Metal Products	Gardena	CA		
Washer	F 436 CS Gv	M/C 67801		12/8/1998	APPR

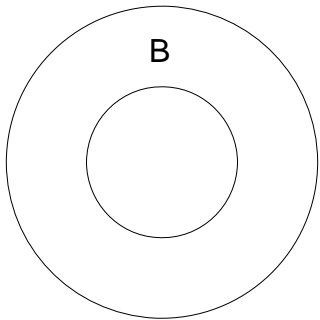

216-01	Binder Metal Products	Gardena	CA		
Washer	F 436 Ty 3 WS Blk	M/C 65702		6/7/1999	APPR

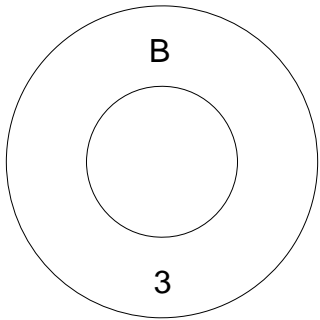

P/S#	Psname	City	State	EDate	Status
216-01	Binder Metal Products	Gardena	CA		
Washer	F 436 Ty 3 WS Gv	M/C 67818		6/7/1999	APPR

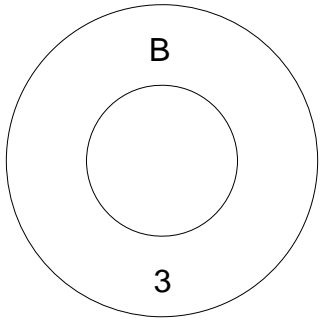

P/S#	Psname	City	State	EDate	Status
------	--------	------	-------	-------	--------

4688-01

4688-01 Graham Stamping Wheatland PA
 Washer F 436 CS Blk M/C 65701 12/8/1998 APPR

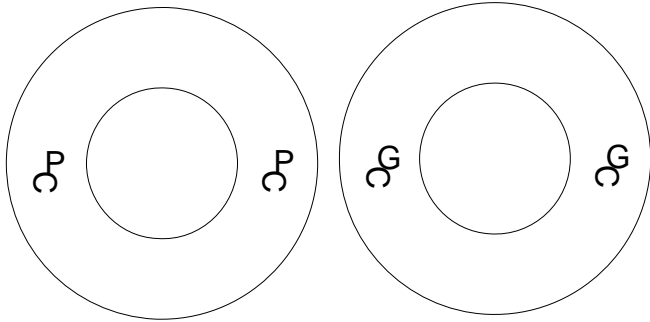

4688-01 Graham Stamping Wheatland PA
 Washer F 436 CS Gv M/C 67801 12/8/1998 APPR

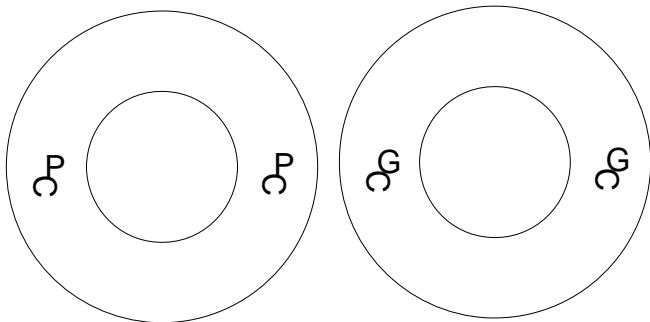

4688-01 Graham Stamping Wheatland PA
 Washer F 436 Ty 3 WS Blk M/C 65702 12/8/1998 APPR

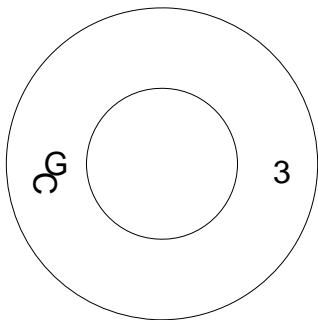

P/S#	Psname	City	State	EDate	Status
4688-01	Graham Stamping	Wheatland	PA		
Washer	F 436 Ty 3 WS Gv	M/C 67818		12/8/1998	APPR

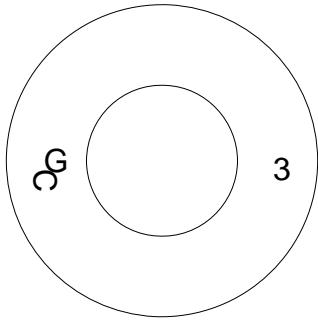

P/S#	Psname	City	State	EDate	Status
------	--------	------	-------	-------	--------

4344-01

4344-01 J & M Turner Southampton PA
 Washer F 959 DTI A 325/490 Blk/ M/C 67819/6782 12/8/1998 APPR

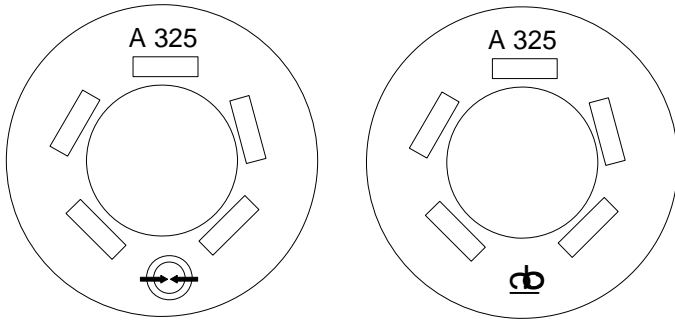

4344-01 J & M Turner Southampton PA
 Washer F 959 DTI A 490 Blk M/C 67821 12/8/1998 APPR

In the case of ASTM A-490, 490 will replace the 325.

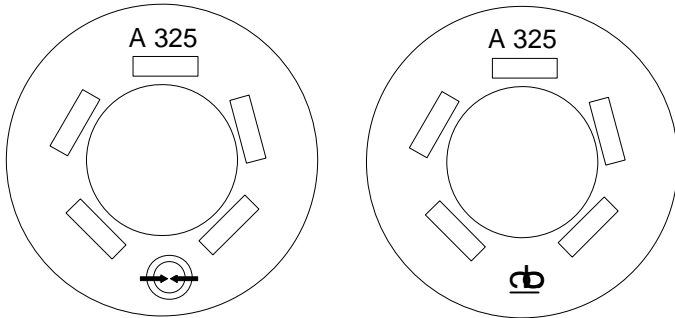

P/S#	Paname	City	State	EDate	Status
------	--------	------	-------	-------	--------

4555-01

4555-01	J.L.K. Industries	Houston	TX		
Washer	F 436 CS Blk	M/C 65701		12/8/1998	APPR

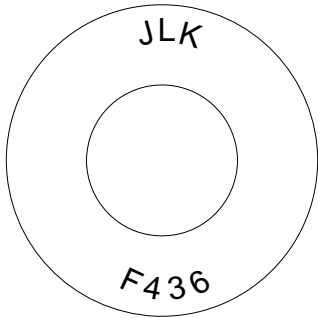

4555-01	J.L.K. Industries	Houston	TX		
Washer	F 436 CS Gv	M/C 67801		12/8/1998	APPR

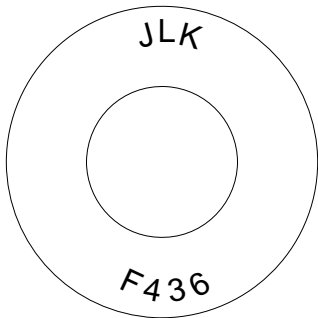

4555-01	J.L.K. Industries	Houston	TX		
Washer	Stainless Steel	M/C 67806		12/8/1998	APPR

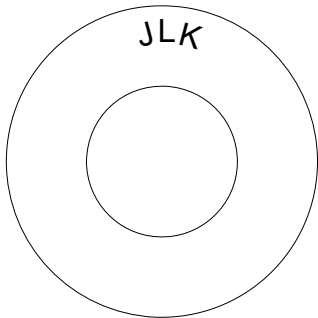

Marked only on request

P/S#	Psname	City	State	EDate	Status
------	--------	------	-------	-------	--------

4619-01

4619-01	MNP Manufacturing Corp.	Utica	MI		
Washer	F 436 CS Blk	M/C 65701		5/3/2006	APPR

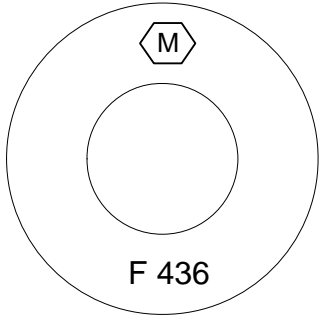

4619-01	MNP Manufacturing Corp.	Utica	MI		
Washer	F 436 CS Gv	M/C 67801		5/3/2006	APPR

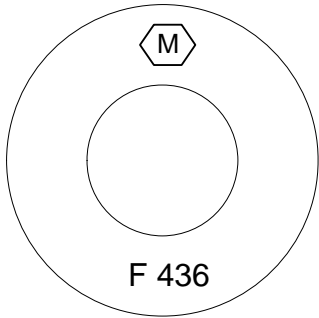

P/S#	Paname	City	State	EDate	Status
------	--------	------	-------	-------	--------

3279-01

3279-01 Prestige Stamping Warrem MI
 Washer F 436 CS Blk M/C 65701 6/7/1999 APPR

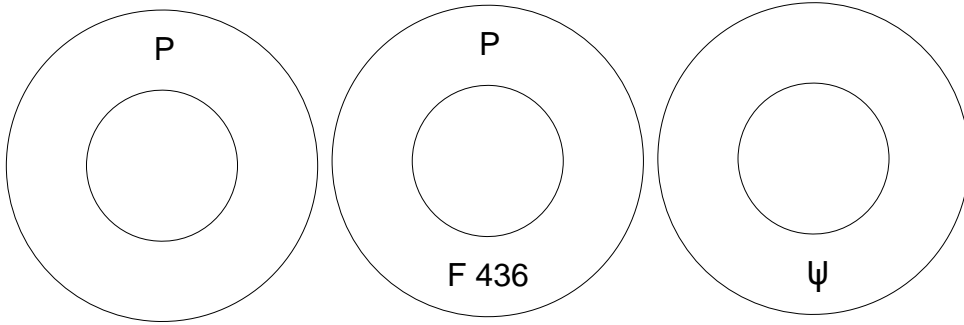

3279-01 Prestige Stamping Warrem MI
 Washer F 436 CS Gv M/C 67801 6/7/1999 APPR

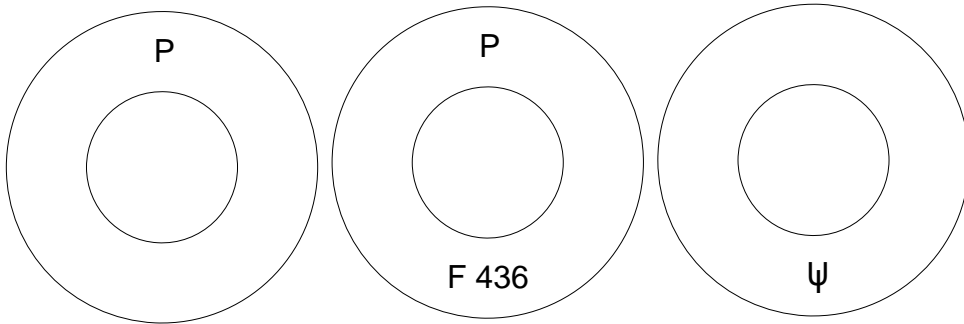

3279-01 Prestige Stamping Warrem MI
 Washer F 436 Ty 3 WS Blk M/C 65702 10/3/2008 APPR

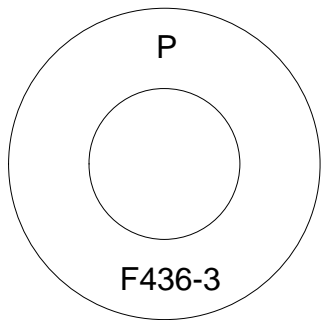

P/S#	Paname	City	State	EDate	Status
------	--------	------	-------	-------	--------

5165-01

5165-01 Technical Stamping Mt. Clemens MI
Washer F 436 CS Blk M/C 65701 12/8/1998 APPR

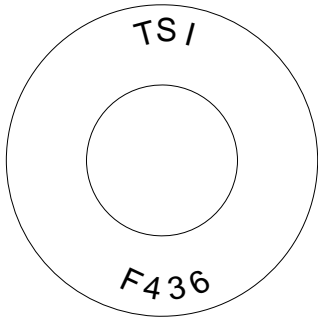

5165-01 Technical Stamping Mt. Clemens MI
Washer F 436 CS Gv M/C 67801 12/8/1998 APPR

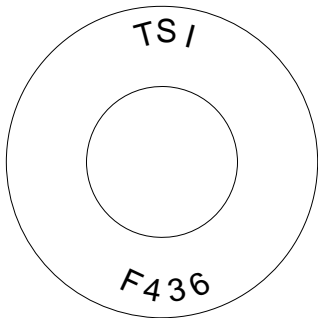

5165-01 Technical Stamping Mt. Clemens MI
Washer F 436 Ty 3 WS Blk M/C 65702 5/23/2008 APPR

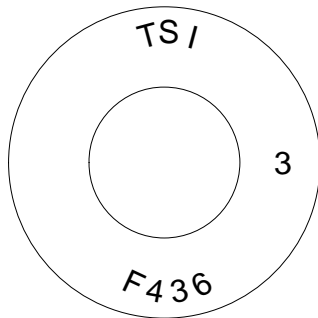

P/S#	Psname	City	State	EDate	Status
------	--------	------	-------	-------	--------

5784-01

5784-01 Turnasure LLC Brooklyn Par MN
 Washer F 959 DTI A 325 Blk/Gv M/C 67819/6782 10/18/2001 APPR

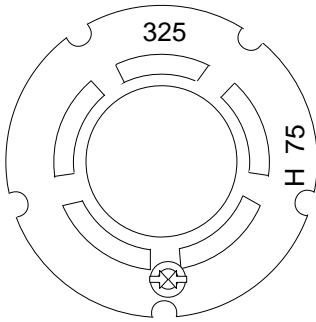

5784-01 Turnasure LLC Brooklyn Par MN
 Washer F 959 DTI A 490 M/C 67821 10/18/2001 APPR

In the case of ASTM A-490, 490 will replace the 325.

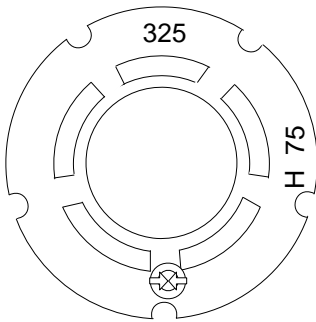

P/S#	Paname	City	State	EDate	Status
------	--------	------	-------	-------	--------

4611-01

4611-01	Washers, Inc.	Livonia	MI		
Washer	F 436 CS Blk	M/C 65701		12/8/1998	APPR

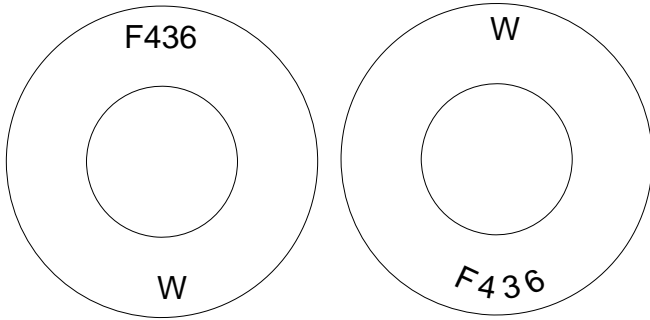

4611-01	Washers, Inc.	Livonia	MI		
Washer	F 436 CS Gv	M/C 67801		12/8/1998	APPR

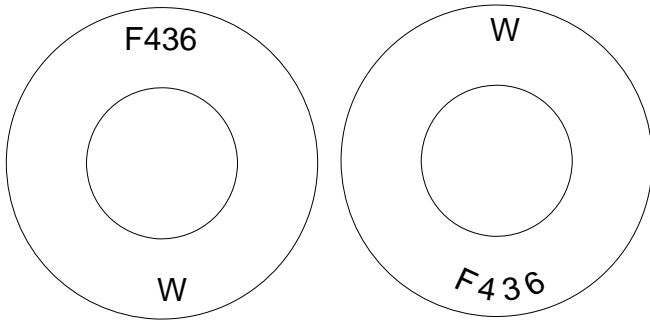

4611-01	Washers, Inc.	Livonia	MI		
Washer	F 436 Ty 3 WS Blk	M/C 65702		12/8/1998	APPR

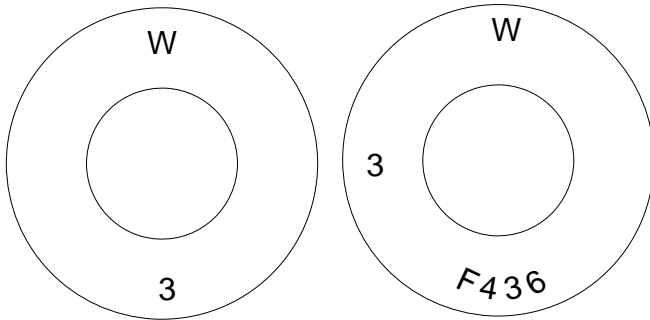

P/S#	Psname	City	State	EDate	Status
4611-01	Washers, Inc.	Livonia	MI		
Washer	F 436 Ty 3 WS Gv	M/C 67818		12/8/1998	APPR

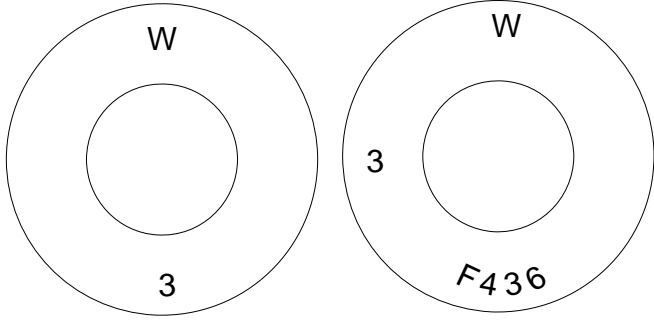

P/S#	Paname	City	State	EDate	Status
------	--------	------	-------	-------	--------

2172-01

2172-01 Wrought Washer Mfg. Co. Milwaukee WI
 Washer F 436 Blv Blk M/C 67808 12/8/1998 APPR

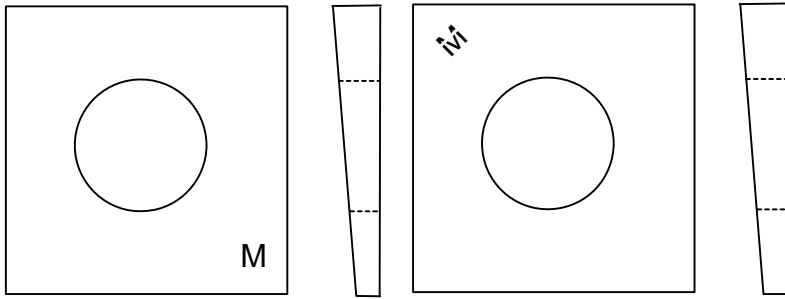

2172-01 Wrought Washer Mfg. Co. Milwaukee WI
 Washer F 436 Blv Gv M/C 67809 12/8/1998 APPR

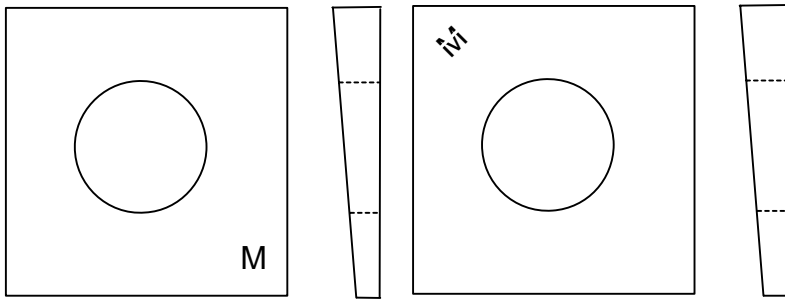

2172-01 Wrought Washer Mfg. Co. Milwaukee WI
 Washer F 436 CS Blk M/C 65701 12/8/1998 APPR

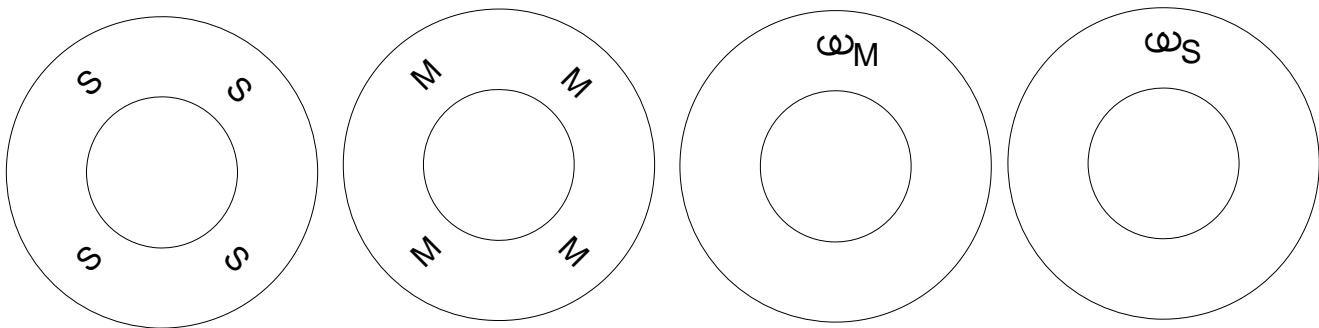

P/S#	Psname	City	State	EDate	Status
------	--------	------	-------	-------	--------

2172-01 Wrought Washer Mfg. Co. Milwaukee WI
Washer F 436 CS Gv M/C 67801 12/8/1998 APPR

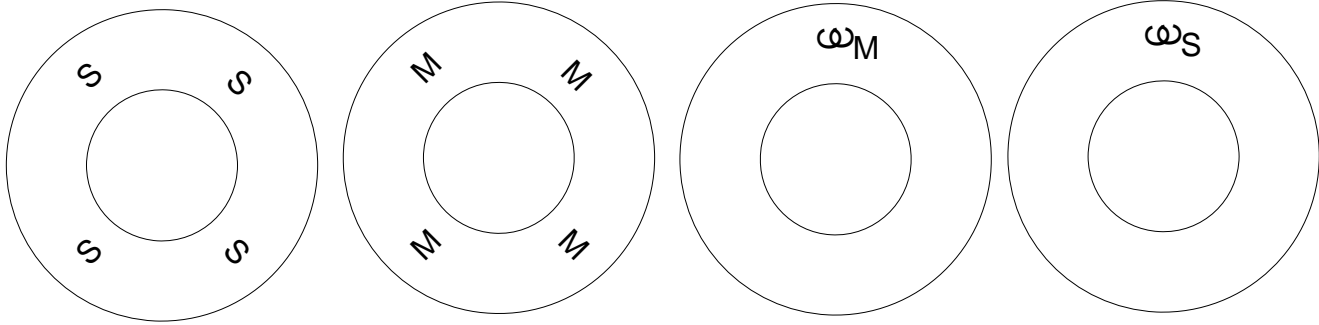

2172-01 Wrought Washer Mfg. Co. Milwaukee WI
Washer F 436 Ty 3 WS Blk M/C 65702 12/8/1998 APPR

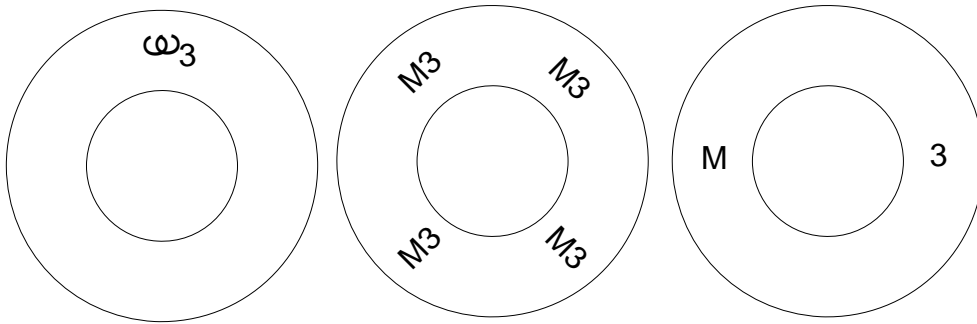

2172-01 Wrought Washer Mfg. Co. Milwaukee WI
Washer F 436 Ty 3 WS Gv M/C 67818 12/8/1998 APPR

